

PISTON RING SETS SIZE LIST Vol.22



MADE IN JAPAN

PISTON RING SETS SIZE LIST

For Japanese Vehicles Vol.22

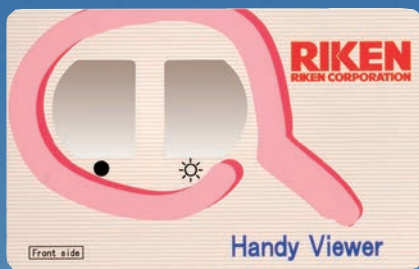

Contents

1. Automobile Piston Rings	2
■ Piston Ring Details, Identification and Location	2
■ Piston Ring Surface Treatment	4
■ Main Structural Materials for Piston Ring	6
2. Piston Ring Sets	8
3. Car makers	13
DAIHATSU MOTOR CO., LTD.	14
FUJI HEAVY INDUSTRIES, LTD.	17
HINO MOTORS, LTD.	19
ISUZU MOTORS, LTD.	27
MITSUBISHI MOTORS CORP.	39
NISSAN MOTOR CO., LTD.	56
NISSAN DIESEL CO., LTD. [UD TRUCKS CORP.]	72
TOYOTA MOTOR CORP.	76
MAZDA MOTOR CORP.	93
SUZUKI CORP.	101
HONDA MOTOR CO., LTD.	104
KOREAN CAR	110

目次

1. 自動車用ピストンリング	2
■ピストンリング各部の名称	2
■ピストンリングの表面改質	4
■ピストンリングの主な材料	6
2. セット構成の説明	8
3. カーメーカー	13
ダイハツ工業(株)	14
富士重工業(株)	17
日野自動車工業(株)	19
いすゞ自動車工業(株)	27
三菱自動車工業(株)	39
日産自動車(株)	56
日産ディーゼル工業(株) [UDトラック(株)]	72
トヨタ自動車(株)	76
マツダ(株)	93
スズキ(株)	101
本田技研工業(株)	104
韓国車	110



DAIHATSU MOTOR CO., LTD.
FUJI HEAVY INDUSTRIES, LTD.
HINO MOTORS, LTD.
ISUZU MOTORS, LTD.
MITSUBISHI MOTORS CORP.
NISSAN MOTOR CO., LTD.
NISSAN DIESEL CO., LTD.
TOYOTA MOTOR CORP.
MAZDA MOTOR CORP.
SUZUKI CORP.
HONDA MOTOR CO., LTD.
KOREAN CAR

1. Automobile Piston Rings 自動車用ピストンリング

■ Piston Ring Details, identification and location ピストンリング各部の名称

自由状態における名称及び記号

Nomenclature and symbols under free state

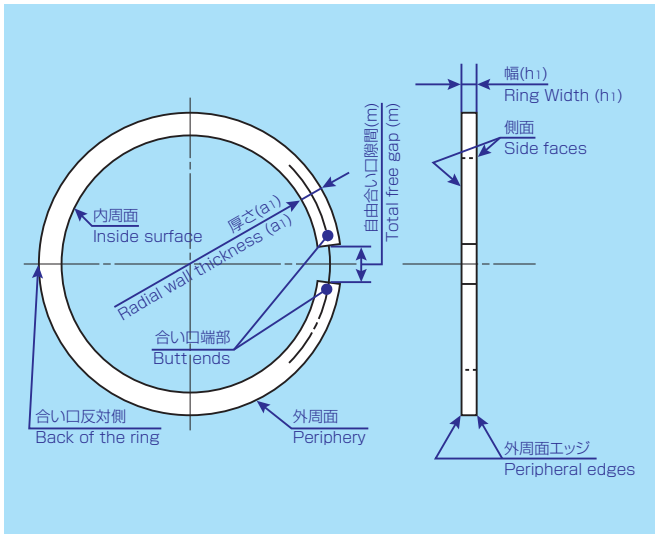

装着状態における名称及び記号

Nomenclature and symbols under mounted state

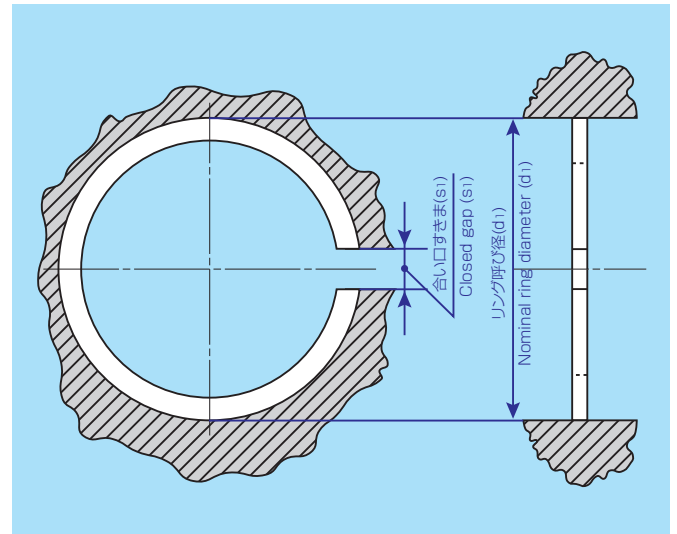

リング断面、溝幅に関する名称及び記号

Nomenclature and symbols relating to ring cross-section and groove width

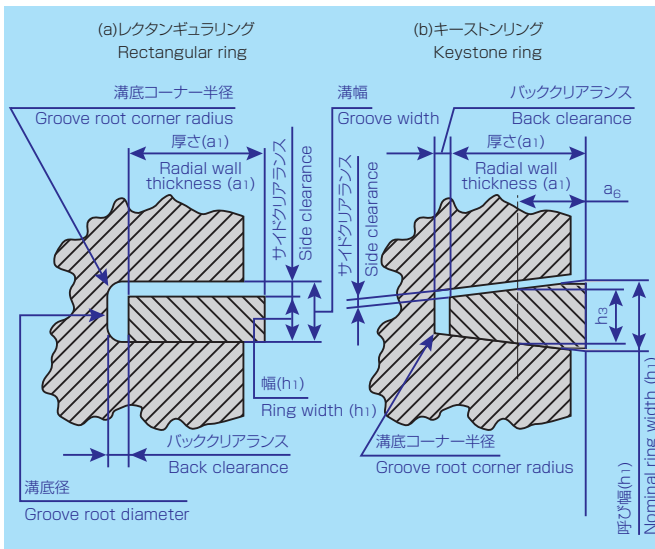

各部の名称 (ピストン)

Nomenclature of parts (Piston)

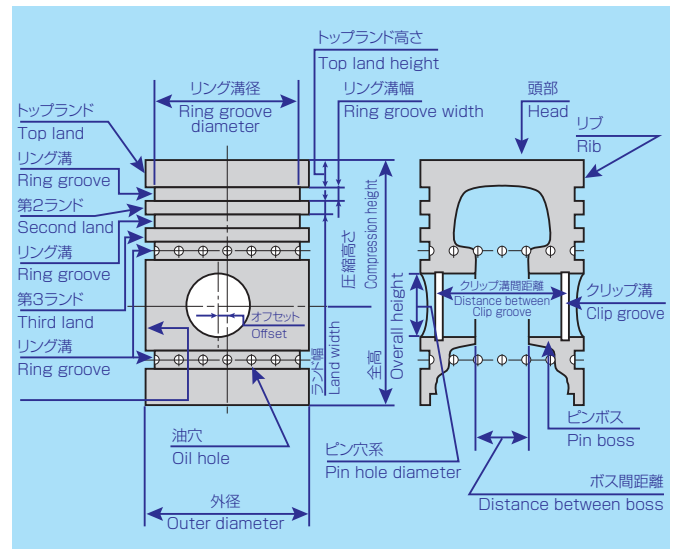

エッジ、内外周、側面の名称

Nomenclature of edges, inside and peripheral surfaces and side face

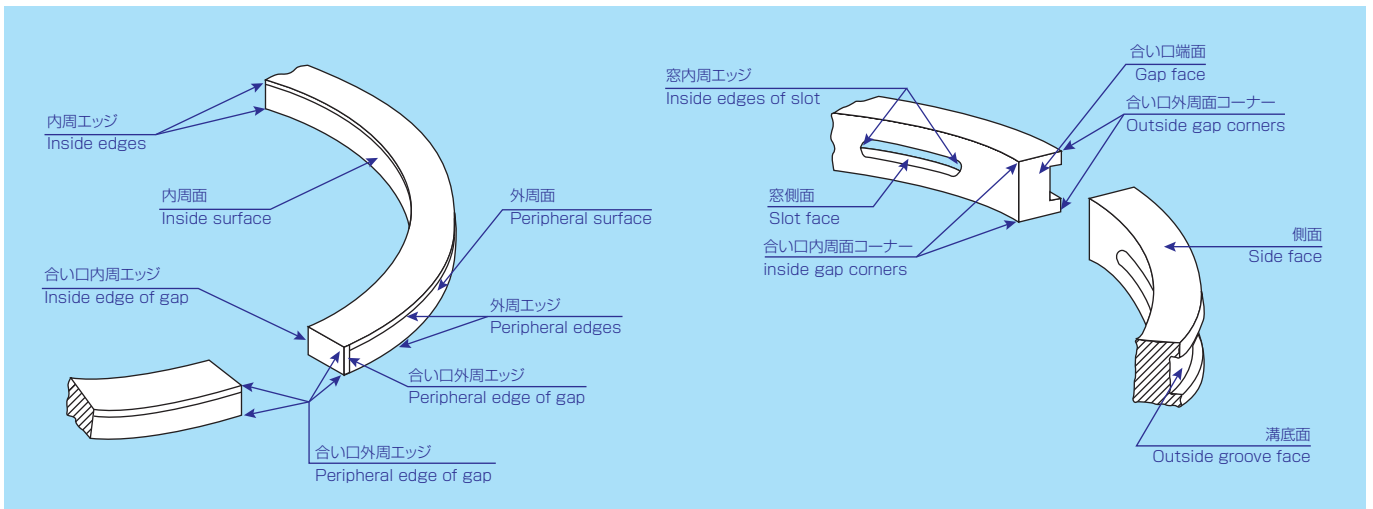

1) 断面形状 Cross-section configurations

レクタングュラリング	Rectangular ring	
キーストンリング	Keystone ring	
ハーフキーストンリング	Half keystone ring	
スクレーパリング (ステップ)	Scraper ring (stepped)	
ナビアリング (アンダカットステップ)	Napier ring (under-cut stepped)	
窓付きオイルコントロールリング	Slotted oil control ring	
ベベルオイルコントロールリング	Bevelled-edge oil control ring	
ダブルベベルオイルコントロールリング	Double-bevelled oil control ring	
コイルエキスパンダ付きオイルコントロールリング	Coil spring loaded oil control ring	
コイルエキスパンダ付きベベルオイルコントロールリング	Coil spring loaded Bevelled-edge oil control ring	
コイルエキスパンダ付きダブルベベルオイルコントロールリング	Coil spring loaded double Bevelled-edge oil control ring	
スチール組合せオイルコントロールリング	Expander / segment oil control ring	

2) 外周形状 Face configurations

ストレートフェイス	Straight-faced	
バレルフェイス	Barrel-faced	
テーパフェイス	Taper-faced	

3) エッジ部形状 Edge configurations

上面インターナルベベル [正ねじ (撮) れタイプ]	Internal bevel top (positive twist type)	
上面インターナルステップ (正ねじれタイプ)	Internal step top (positive twist type)	
下面インターナルベベル (逆ねじれタイプ)	Internal bevel bottom (negative twist type)	
下面インターナルステップ (逆ねじれタイプ)	Internal step bottom (negative twist type)	
内周面取り	Inside edges chamfered	
外周面取り	Outside edges chamfered	
内外周面取り	Inside and outside edges chamfered	

4) コーティング部形状 Coating configurations

コーティングなし	Uncoated	
コーティング付き 外周全面	Coated fully faced	
コーティング付き セミインレイド	Coated semi-inlaid	
コーティング付き インレイド	Coated inlaid	

5) 合口部形状 Joint configurations

直角合い口 (ストレート)	Joint (straight)	
斜め合い口 (アングル)	Oblique joint (angle)	
段付き合い口 (ステップ)	Stepped joint (angle)	
側面回り止め	Joint with side notch	
内周回り止め	Joint with internal notch	

■ Piston Ring Surface Treatment

ピストンリングの表面改質

●ピストンリングの代表的な表面改質技術

Typical Surface Treatment Technology for Piston Ring

表面処理の種類 Type of Surface Treatment		使用目的 Application Applicable Engine								用途例		
表面処理名 Surface treatment		記号 Symbol	硬さ Hardness (HmV)	防錆 (防錆油併用) Rust prevention used together with rust preventives	初期なじみ Initial break-in	耐摩耗性 Wear resistance	側面摩耗 Side wear prevention	耐側面凝着 Side stick prevention	Al合金 シリンダ用 Aluminum alloy cylinder	ガソリンエンジン Gasoline engine		ディーゼル エンジン Diesel engine
									無鉛 Unleaded	有鉛 Leaded		
電気めっき Electro-plating	外周クロムめっき Surface chromium plating	Cr 1	800 ~ 1100			●				●	●	●
	クロムインサート Chromium insert	Cr 2	800 ~ 1100			●						●
	側面クロムめっき Side chromium plating	Cr 3	800 ~ 1100				●					●
	全面クロムめっき Full chromium plating	Cr 4	800 ~ 1100							●		●
窒化処理 Nitriding	ガス窒化 Gas Nitriding	GN	700<			●	●		●	●	●	
電気複合めっき Composite electro-plating	ニッケル系 Nickel base	CPN	800 ~ 1100		●	●		●	●	●	●	
溶射 Spraying	金属系溶射 Metal spraying	RF	700<			●					●	●
	セラミック溶射 Ceramic spraying	RF	700<			●					●	●
化成処理 Compound processing	リン酸亜鉛系皮膜 Phosphoric zinc film	RPK-10	—	●						●	●	●
		RPK-11	—	●						●	●	●
		RPK-12	—	●				●		●		
	リン酸マンガン系皮膜 Phosphoric manganese film	RPK-25	—	●	●			●		●	●	
		RPK-26	—	●	●			●		●	●	
		RPK-27	—	●	●			●		●	●	
		RPK-28	—	●	●			●		●	●	
フェロックス処理 Ferox treatment	RPK-30	—	●						●	●		
電気めっき+逆電処理 Electro-plating + Reverse current treatment	QB クロムめっき QB chromium plating	QBC	800 ~ 1100		●	●			●	●		

A. 硬質クロムめっき (Cr)

硬質クロムめっきは、金属クロム本来の性質に電着物特有の性質を兼ね備えた優れた特性をもっています。その主な特長は、

1. 硬さがきわめて高い。ビッカース硬さ 800 ~ 1100 (普通鉄 220 ~ 270)
2. 溶融点が高い。約 1800°C (普通鉄 1200°C程度)
3. 熱伝導性、耐食性に優れる。
4. 摩擦係数が小さく、耐摩耗性に優れる。

などの特性を保持しているため、ピストンリングの摩耗防止対策として非常に効果的です。

この硬質クロムめっきの開発によって、エンジン性能を大幅に飛躍させたことは申すまでもありません。このため、小型エンジン用ピストンリングはもとより、中型エンジンにも用いられています。また、高圧圧縮機にも保油性のあるポーラスにしたクロムめっきが施されています。

●硬質クロムめっきの耐摩耗性

下のデータは高級鉄リング材と硬質クロムめっきの摩擦摩耗試験結果です。相手材には普通鉄を使用。硬質クロムめっきは高級鉄の約 7 ~ 8 倍も磨耗しにくいことが、このデータからもはっきりおわかりいただけると思います。このことは摩耗条件によっても大きく変わりますが、一般の正常運転でのガソリン・ディーゼルエンジンに組付けられた場合でも、ほぼ同様の摩耗結果が得られます。

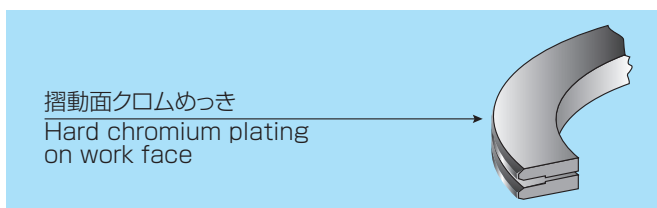
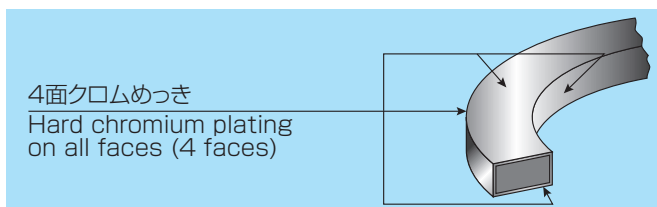
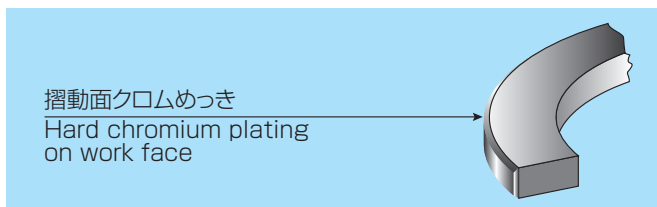

Hard Chromium Plating (Cr)

The hard chromium plating layer has excellent characteristics which combine the original properties of chromium metal with the advantages of electro-deposits. The main features of hard chromium plating are as follows:

1. Extremely high hardness of HmV (Micro Vickers) 800 to 1100 (cf. gray cast iron 220 to 270)
2. High melting point of approx. 1800°C (cf. cast iron 1200°C)
3. Good thermal conductivity and corrosion resistance.
4. Low friction factor and excellent wear resistance. Such features are very effective in preventing piston ring wear.

With the development of this hard chromium plating, engine performance has been greatly improved. It is applied to piston rings for medium sized engine as well as small sized engines. Porus chromium plating which has oil retaining properties is used for high pressure compressors.

Wear resistance of hard chromium plating

The following table shows the results of friction and wear tests on high grade cast iron and hard chromium plating. Gray cast iron was used for the mating material. As shown, it is evident that wear resistance of hard chromium plating is about 7 to 8 times higher than cast iron.

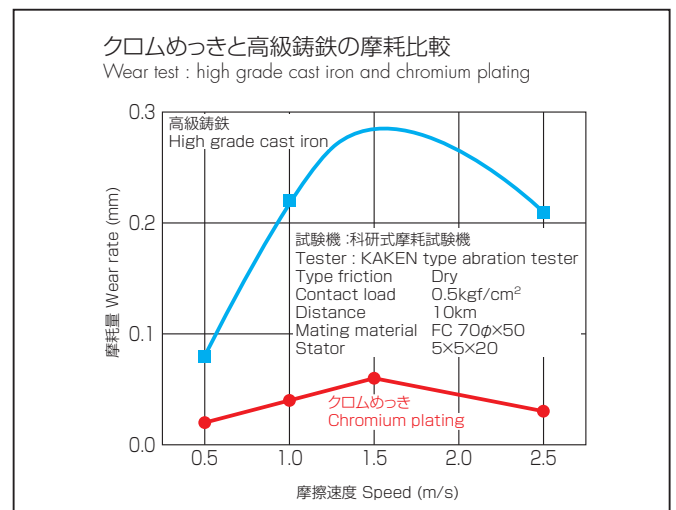

■ Main Structural Materials for Piston Ring ピストンリングの主な材料

STEEL

RIK-SP is a steel selected and improved as material suitable for piston rings. It is used to produce compression rings for small high speed engines and side rails for combination oil rings. It is also used for high-performance oil ring [DIESELVENT-M] for diesel engines.

RIK-SS is easy to form, excellent in spring characteristics and highly resistive to permanent set in thermal fatigue. It is widely used for combination oil ring [RIKVENT] spacer in various engine versions.

HI-RIK

HI-RIK is a high elastic material and it shows a modulus of elasticity of 147 to 167 GPa which is close to steel modulus of elasticity 196 GPa. The reason for this is that the configuration of graphite (nodular and tempered) shows low notch effect. It has excellent wear resistance which is top ranked among currently available cast iron types.

HI-RIK is suitable for such applications as automobiles, vessels, construction equipment, aircraft which require high modulus of elasticity and break-resistance.

RIK-S

RIK-S is a tough cast iron provided with excellent physical and mechanical properties by a special refining process without addition of any alloying element. It offers adequate elastic modulus and hardness, is easy to break in and is relatively high in shock resistance.

●スチール（鋼）

RIK-SP は、ピストンリングに適合した材料として選定、改良された鋼材です。小型高速機関の圧力リングや、組み合わせオイルリングのサイドレールに使用します。

また、ディーゼル用高性能オイルリング「ディーゼルベント-M」にも使用されています。

RIK-SS は、成形性や、スプリング特性、耐熱ヘタリ性に優れ、組み合わせオイルリング「リックベント」のスペーサー材として、多岐にわたる機関仕様に応じて選択使用されています。

●ハイリック

ハイリックは高弾性材で、標準弾性率は 147～167GPa で鋼の 196GPa に近い値を示します。このことは、鑄鉄の機械的特性を大きく左右する黒鉛形状が、切欠効果の少ない球状黒鉛鑄鉄や焼き戻し黒鉛と緻密なパーライトやアシキュラーからなっているためです。

耐摩耗性においては格段優れており、現存する鑄鉄中で最高位にランクされています。ハイリックは、自動車、船舶、建設機械、航空機等で、特に高弾性率と耐折損性が要求される圧力リング、油かきリングに適しています。

●リック-S

リック-S は、特殊な精錬技術により、合金元素の添加を行なわないで、優れた物理的特性を具備させた強靱鑄鉄で、弾性率も硬さも適度に得られ、なじみ性もよく、衝撃に対する抵抗力も比較的優れています。

ピストンリングの表面
Piston Ring Surface

×400%



スチール STEEL
RIK SP-5

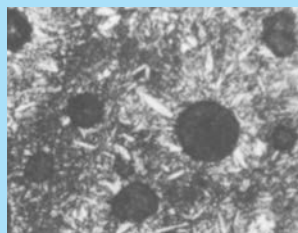

ハイリック HI-RIK
RIK-20A

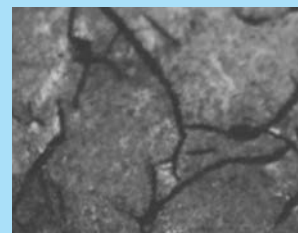

リック-S RIK-S
RIK-42A

2. Piston Ring Sets

セット構成の説明

[V Series]

FV type

This ring set is extensively used with various sizes of high-performance 4-cycle gasoline engine cylinders ranging from approx. 50mm to 100 mm in bore diameter. It features the steel-made, high performance oil ring [RIK VENT] which is highly capable of oil scraping and elaborately designed for optimum fit in the ring groove to ensure the side sealing effect.

This type is best suited to reduce oil loss due to a deformed cylinder or an undulating ring groove in a 4-cycle gasoline engine.

SV type

This is a sophisticated version of the FV type piston ring set featuring the FV type top ring in high strength steel.

[V シリーズ]

● FV タイプ

高性能 4 サイクルガソリンエンジン用の $\phi 50$ 位から $\phi 100$ 程度までのシリンダーサイズに広く使用されているリングセットで、オイルリング溝とオイルリングによるサイドシール性を考慮した高性能なオイル掻き能力を備えたスチール製オイルリング「リックベント」を使用したリングセットです。

4 サイクルガソリンエンジンでの、シリンダーの変形やオイルリング溝のうねりなどによるオイル消費量増大の抑制に最適なピストンリングセットです。

● SV タイプ

FV タイプのトップリングに高強度のスチールリングを使用したピストンリングセットです。

Ring 種別	Cross-section Configuration 断面形状	Cross-section Configuration 断面形状	Cross-section Configuration 断面形状	Cross-section Configuration 断面形状
Top				
2ND				
OIL				



[X Series]

FX type

This piston ring set features the use of the coil expander installed in the inner surface of the oil ring to enhance conformability to the wall surface of the cylinder, ensuring high oil scraping capability. It is extensively used with pistons in high performance diesel engines and gasoline engines of passenger cars, buses, trucks and construction vehicles.

Another advantage is that it is highly effective in reducing oil loss due to a deformed cylinder.

SX type

This is a sophisticated version of the FX type piston ring set featuring the FX type top ring in high strength steel.

[X シリーズ]

● FX タイプ

オイルリングの内周面にコイルエキスパンダーをセットすることにより、シリンダー壁面への追従性を向上させた、高性能なオイル掻き能力を備えたピストンリングセットです。高性能ディーゼルエンジン用として、乗用車、バス、トラックなど、また建設車両用としても広く使用されています。

シリンダー変形などによるオイル消費量増大の抑制に優れています。

● SX タイプ

FX タイプのトップリングに高強度のスチールリングを使用したピストンリングセットです。

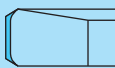
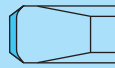
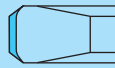
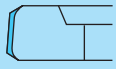
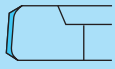
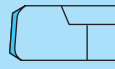
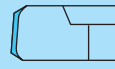
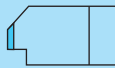
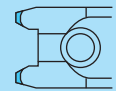
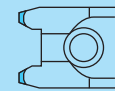
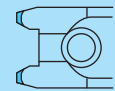
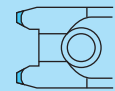
Ring 種別	Cross-section Configuration 断面形状	Cross-section Configuration 断面形状	Cross-section Configuration 断面形状	Cross-section Configuration 断面形状
Top				
2ND				
3RD				
OIL				

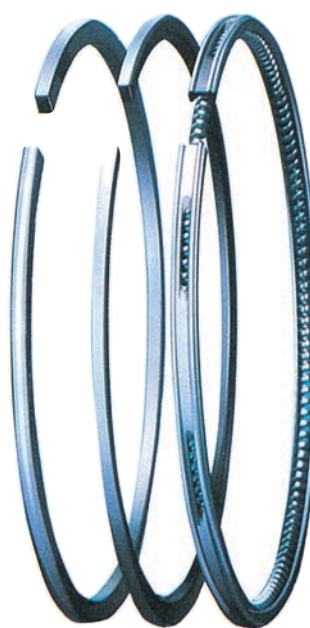
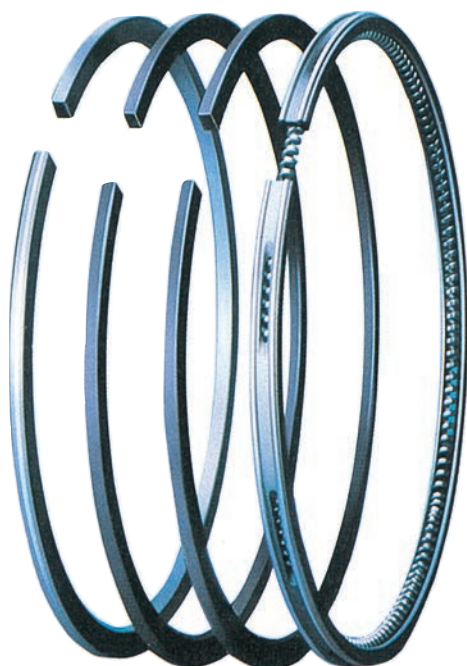

[M Series]

FM type

The use of a steel oil ring (DIESEL VENT-M) makes this piston ring set capable of effectively ensuring optimum oil control over a long period with minimum oil consumption. This type is used with diesel engines in passenger cars, buses, trucks and construction vehicles.

SM type

This is a sophisticated version of the FM type featuring the FM type top ring in high strength steel.

[M シリーズ]

● FM タイプ

オイルリングにスチール製の「ディーゼルベント M」をセットすることにより、理想的なオイルコントロール作用が長期的に安定し、オイル消費を大幅に低減します。ディーゼルエンジン用として、乗用車、バス、トラック、建設機械用などに使用されています。

● SM タイプ

FM タイプのトップリングに高強度のスチールリングを使用したピストンリングセットです。

Ring 種別	Cross-section Configuration 断面形状	Cross-section Configuration 断面形状	Cross-section Configuration 断面形状	Cross-section Configuration 断面形状
Top				
2ND				
3RD				
OIL				





[E Series]

FE type

In this piston ring set, the rear plate of the 2nd ring is combined with an expander to achieve a reduction in slap sound. This set is widely used for 2-stroke gasoline-line engines.

SE types

This piston ring set has a high strength steel ring for the FE type top ring.

Ring 種別	Cross-section Configuration 断面形状
Top	
2ND	

[E シリーズ]

● FE タイプ

2ND リングの背面に板エキスパンダを組み合わせることで、ピストンのスラップ音低減に効果を発揮するピストンリングセットです。

2 サイクルガソリンエンジン用として、広く使用されています。

● SE タイプ

FE タイプのトップリングに高強度のスチールリングを使用したピストンリングセットです。

[O Series]

FO type













This piston ring set is a combination of a top ring with a surface treated outer surface such as chromium plating, a second ring and a coil expanderless ring. This is the most common type widely used with 4-cycle gasoline engines and diesel engines in various vehicles ranging from motorcycles to buses and trucks.

[O シリーズ]

● FO タイプ

外周面にクロムめっきなどの表面改質を施したトップリングを使用し、コイルエキスパンダーを使用しないオイルリングと組み合わせたピストンリングセットです。

4 サイクルのガソリンエンジン用、ディーゼルエンジン用で、2 輪車からバス、トラックなどの大型車まで、幅広く使用されているもっともオーソドックスなピストンリングセットです。

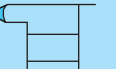
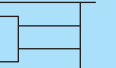
Ring 種別	Cross-section Configuration 断面形状	Cross-section Configuration 断面形状	Cross-section Configuration 断面形状	Cross-section Configuration 断面形状
Top				
2ND				
3RD				
OIL				
OIL				

[N Series]

FN type

This is a piston ring set without an oil ring for 2-cycle engines. Either the top ring only, or both rings have their surfaces treated to ensure long surface life.

SN type

This is a sophisticated version of the FN type featuring the FN type top ring in high strength steel.

[N シリーズ]





● FN タイプ

オイルリングを使用しない2サイクルガソリンエンジン用のピストンリングセットです。

トップリングのみ、あるいは、トップリングとセカンドリングの両リングの外周面に表面改質を施すことにより、長寿命化を図っています。

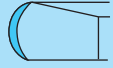
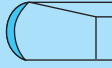
● SN タイプ

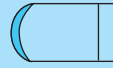
FN タイプのトップリングに高強度のスチールリングを使用したピストンリングセットです。

Ring 種別	Cross-section Configuration 断面形状	Cross-section Configuration 断面形状	Cross-section Configuration 断面形状	Cross-section Configuration 断面形状
Top				
2ND				

PISTON RING SETS SIZE LIST

For Japanese Vehicles Vol.22

DAIHATSU MOTOR CO., LTD.	14
FUJI HEAVY INDUSTRIES, LTD.	17
HINO MOTORS, LTD.	19
ISUZU MOTORS, LTD.	27
MITSUBISHI MOTORS CORP.	39
NISSAN MOTOR CO., LTD.	56
NISSAN DIESEL CO., LTD. [UD TRUCKS CORP.]	72
TOYOTA MOTOR CORP.	76
MAZDA MOTOR CORP.	93
SUZUKI CORP.	101
HONDA MOTOR CO., LTD.	104
KOREAN CAR	110

Engine Type	cc	Vehicle Model Chassis Type	Cyl. No.	Piston Ring						Remarks
				Position	Size (mm) d ₁ ×h ₁ ×a ₁ (D×B×T)	Material	Surface Treatment	Set Type	Set No. ※	

●DAIHATSU MOTOR CO., LTD. ダイハツ工業(株)

○——ガソリン車 Gasoline-engine Automobiles

※(): OLD SET No.

JB-TC	660	●Move	4	1	61 × 1.2 × 2.3			SV	12806	13011-87227
				2	61 × 1.2 × 2.5					
				0	61 × 2 × 2.5					
L38	356	●Fellow Max38 L38S	2	1	62 × 2 × 2.8	RN		FN	12510	13011-87204 13011-87205 13011-87501 IST=HALF KEYSTONE
				2	62 × 2 × 2.8					
				0	62 × 2 × 2.8					
EB	547	●Mira	3	1	62 × 1.2 × 2.3		Cr4	SV	12010	13011-87206 13011-87222
				2	62 × 1.5 × 2.5					
				0	62 × 2.8 × 2.5					
ED-10	847	●Kancil	3	1	66.6 × 1.2 × 2.6		GN	SV	12915 (12535)	13011-87208 13011-87232
				2	66.6 × 1.5 × 2.8					
				0	66.6 × 2.8 × 2.5					
ED(NEW)	847	●Mira Cuore	3	1	66.6 × 1.2 × 2.3		GN	SV	12004	13011-97209
				2	66.6 × 1.2 × 2.6					
				0	66.6 × 2 × 2.2					
D18D	800	●Perodua Viva	3	1	66.6 × 1.2 × 2.3		GN	SV	12003	13011-87Z07
				2	66.6 × 1.2 × 2.6					
				0	66.6 × 2 × 2.2					
FE,FE051	958	●JEEP F40, F40L, F40K ●JEEP F40G, 640V, F40P	4	1	68 × 2 × 3			FV	12800	13011-87103 992-4023-1411
				2	68 × 2 × 3					
				0	68 × 4 × 3.1					
FE	660		3	1	68 × 1.2 × 2.6		Cr4	SV	12020	13011-87218
				2	68 × 1.5 × 2.8					
				0	68 × 2.8 × 2.5					
EF	660	●Kancil Rusa ●Charade	3	1	68 × 1.2 × 2.6			SV	12025	13011-87E02
				2	68 × 1.5 × 2.8					
				0	68 × 2.8 × 2.5					
EF	659	●Mira	4	1	68 × 1.2 × 2.6			SV	12050	13011-97203
				2	68 × 1.2 × 2.8					
				0	68 × 2.5 × 2.5					
CD	850	●G20L	3	1	70 × 1.5 × 3		GN	SV	12531	13011-87712
				2	70 × 1.5 × 3					
				0	70 × 2.8 × 2.8					
EJDE	1000	●Sirion ●Storia	3	1	71 × 1.2 × 2.5			SV	12532	13011-97202
				2	71 × 1.2 × 2.9					
				0	71 × 2.5 × 2.5					
AB	547	●Fellow Max L40, L40V, L45, L50 L55 SS11	2	1	71.6 × 1.5 × 3			FO	12220	13011-87701 13011-87702 13011-87705 13011-87709 13011-87714
				2	71.6 × 1.5 × 3					
				0	71.6 × 2.8 × 3					
ABL40	547		2	1	71.6 × 1.5 × 3			FV	12230 (12240)	13011-87701 13011-87710
				2	71.6 × 1.5 × 3					
				0	71.6 × 2.8 × 2.8					
エンジン型式	排気量	車名・型式	シリン ダー数	位置	サイズ 径×中×厚さ	材質	表面改質	セットタイプ	セットNo.	備考
ピストンリング										

Engine Type	cc	Vehicle Model Chassis Type	Cyl. No.	Piston Ring						Remarks
				Position	Size (mm) d ₁ ×h ₁ ×a ₁ (D×B×T)	Material	Surface Treatment	Set Type	Set No. ※	

統 DAIHATSU MOTOR CO., LTD. ダイハツ工業株

○ — ガソリン車 Gasoline-engine Automobiles

※ (): OLD SET No.

K3	1300	●Storia M100S,M110S	4	1	72 × 1.2 × 2.55			SV	12125	13011-97401
				2	72 × 1.2 × 2.6					
				0	72 × 2 × 2.2					
EJ	989	●Perodua ●Kelisa & Kenari ●Storia M100s,M100s	3	1	72 × 1.2 × 2.55			SV	12015	13011-97201-000 13011-97210
				2	72 × 1.2 × 2.9					
				0	72 × 2.5 × 2.5					
CB	993	●Charade G10 EG10 CB10,CB20,CB50	3	1	76 × 1.5 × 3.2			FV	12300	13011-87704 13011-87708 13011-87703
				2	76 × 1.5 × 3.2					
				0	76 × 2.8 × 3.1					
CB	993	●Charade G10 EG10 CB10,CB20,CB50	3	1	76 × 1.5 × 3.2		Cr4	FV	12280	13011-87718
				2	76 × 1.5 × 3.2					
				0	76 × 2.8 × 3.1					
CB(NEW)	993	●Charade G10S,G11S HC	3	1	76 × 1.5 × 2.8		GN	SV	12304	13011-87727
				2	76 × 1.5 × 3					
				0	76 × 2.8 × 2.5					
				1	76 × 1.5 × 2.9	GN	FV	12305		
				2	76 × 1.5 × 3					
				0	76 × 2.8 × 2.5					
HC	1295	●Charade G1028,G1128	4	1	76 × 1.2 × 2.8			SV	12600	13011-87105 13011-87108 13011-87104
				2	76 × 1.5 × 3.1					
				0	76 × 3 × 2.8					
HD	1589	●Feroza	4	1	76 × 1.2 × 2.8			SV	12910	13011-87106 13011-87107 13011-87109 13011-87110 13011-87111
				2	76 × 1.5 × 3.2					
				0	76 × 3 × 2.5					
FB	1861	●Delta 2000	4	1	85 × 2 × 3.9			FO	12490	13011-87301
				2	85 × 2 × 3.9					
				0	85 × 4 × 3.9					
エンジン型式	排気量	車名・型式	シリンダー数	位置	サイズ 径×巾×厚さ	材質	表面改質	セットタイプ	セットNo.	備考
ピストンリング										

Engine Type	cc	Vehicle Model Chassis Type	Cyl. No.	Piston Ring						Remarks
				Position	Size (mm) d ₁ ×h ₁ ×a ₁ (D×B×T)	Material	Surface Treatment	Set Type	Set No. [※]	

⑧ DAIHATSU MOTOR CO., LTD. ダイハツ工業株式会社

○ ———— ディーゼル車 Diesel-engine Automobiles

※ (): OLD SET No.

CL10	1000	●Charade G30	3	1	76 × 2 × 3.2	RN	Cr4	FX	12290	13011-87717
				2	76 × 1.5 × 3.1		Cr4			13011-87723A
				0	76 × 3 × 2.3	RN				IST=HALF KEYSTONE
CL(NEW)	1000	●Charade (Diesel)	4	1	76 × 2 × 2.8		GN	SM	12001	13011-87721
				2	76 × 1.5 × 3.1					
				0	76 × 3 × 1.95					IST=HALF KEYSTONE
DF	2270	●DV202, DL200, DL22L, D200, DV227, DV22D, ●SV22, SV22H, SV20H	4	1	85 × 2 × 3.5		Cr4	FX	12700	992-4223-1411
				2	85 × 2 × 3.5					992-4113-1410,1411
				3	85 × 2 × 3.5					992-4113-1412
				0	85 × 4 × 2.9					992-4223-1412
DG	2530	●DV26, SV18, SV26 ●SV32, SV37	4	1	88 × 2 × 3.8		Cr4	FX	12500	992-5113-1410
				2	88 × 2 × 3.8					
				3	88 × 2 × 3.8					
				0	88 × 4 × 2.8					
				0	88 × 4 × 2.8					
DG(NEW)	2530	●D300(NEW) ●V23, 24, 25, 26 ●Small Bus F50V	4	1	88 × 2.5 × 3.8		Cr4	FX	12090	13011-87305
				2	88 × 2 × 3.8					13011-87306
				0	88 × 4 × 2.8					13011-87308 13011-87307
DG	2530		4	1	88 × 2 × 3.8		Cr4	FX	12520	13011-87304-000
				2	88 × 2 × 3.8					
				3	88 × 2 × 3.8					
				0	88 × 4 × 2.8					
DL	2765		4	1	92 × 2.5 × 3.8		Cr4	FX	12100	13011-87310
				2	92 × 2 × 3.8					13011-87311
				0	92 × 4 × 2.7					13011-87312 13011-87313 13011-87320
DL-T	2765	●Taft Delta	4	1	92 × 2.5 × 3.8			FM	12002	13011-87317
				2	92 × 2 × 3.8					
				0	92 × 4 × 2.45					IST=HALF KEYSTONE
エンジン型式	排気量	車名・型式	シリンダー数	位置	サイズ 径×巾×厚さ	材質	表面改質	セットタイプ	セットNo.	備考
ピストンリング										

Engine Type	cc	Vehicle Model Chassis Type	Cyl. No.	Piston Ring						Remarks
				Position	Size (mm) d ₁ ×h ₁ ×a ₁ (D×B×T)	Material	Surface Treatment	Set Type	Set No. ※	

●FUJI HEAVY INDUSTRIES, LTD. 富士重工業(株)

○——ガソリン車 Gasoline-engine Automobiles

※(): OLD SET No.

EK21A	360	●Subaru-Rex	2	1	66 × 1.5 × 3	RN		FV	14010	48003-1000
				2	66 × 1.5 × 3					
				0	66 × 2.8 × 2.8					
EK22	490	●Subaru-Sumber-5 ●Subaru-R-5	2	1	74 × 1.5 × 3.4	RN		FV	14040	48003-1300
				2	74 × 1.5 × 3.4					
				0	74 × 2.8 × 3.4					
EK23(NEW)	544	●Subaru-Sumber ●Subaru-Rex	2	1	76 × 1.5 × 3.4	RN		FV	14020	48003-5400
				2	76 × 1.5 × 3.4					
				0	76 × 2.8 × 3.4					
EK23	544	●Subaru-Sumber ●Subaru-Rex	2	1	76 × 1.2 × 3.1			SV	14700	48003-5500
				2	76 × 1.5 × 3.4					
				0	76 × 2.8 × 3.4					
EF10	997	●Subaru-Domingo	3	1	78 × 1.2 × 3.1			SV	14480	48003-5700
				2	78 × 1.5 × 3.4					
				0	78 × 2.8 × 3.4					
E42	700	●Subaru-Rex	2	1	78 × 1.2 × 3.1			SV	14750	48003-5610
				2	78 × 1.5 × 3.4					48003-5600
				0	78 × 2.8 × 3.4					
EF10	1000		3	1	78 × 1.2 × 3.1			SV	14470	48003-5800
				2	78 × 1.5 × 3.4					
				0	78 × 2.8 × 3.5					
EF12			3	1	78 × 1.2 × 3			SV	14270	12033-KA181
				2	78 × 1.5 × 3.4					
				0	78 × 2.8 × 3.4					
EA62	1200	●Subaru FF-1-1300	4	1	82 × 2 × 3.8			FV	14500	88003-8600
				2	82 × 2 × 3.8					
				0	82 × 4 × 3.75					
EA65	1298	●Subaru-1300 A-65, AM1	4	1	83 × 2 × 3.8			FV	14120	48003-7000
				2	83 × 2 × 3.8					
				0	83 × 4 × 3.6					
EA65(NEW)	1298	●Subaru-1300 A-65, AM1	4	1	83 × 1.2 × 3.3			SV	14640	48003-7010
				2	83 × 1.5 × 3.6					
				0	83 × 4 × 3.6					
EA63	1361	●Subaru-1400 A-22, B-A22, A32	4	1	85 × 2 × 3.9			FV	14540	38003-0110
				2	85 × 2 × 3.9					
				0	85 × 4 × 3.85					
EA71(NEW)3 EA81	1595 1781	●Subaru-Leone 1600 Sedan ●Subaru-Leone 1600 Van ●Subaru-Leone 1800 Sedan	4	1	92 × 1.2 × 3.6			SV	14510	48003-7100
				2	92 × 1.5 × 3.9					
				0	92 × 4 × 3.9					
EA71	1595	●Subaru-1600 ●Subaru-1800 B-A26, B-27, H-A67, A33, A34, AB2, AF2, AM2, 3, A67	4	1	92 × 2 × 4.1			FV	14200	38003-43
				2	92 × 2 × 4.1					
				0	92 × 4 × 3.9					
エンジン型式	排気量	車名・型式	シリン ダー数	位置	サイズ 径×中×厚さ	材質	表面改質	セットタイプ	セットNo.	備考
ピストンリング										

FUJI HEAVY INDUSTRIES
LTD.
富士重工業(株)

Engine Type	cc	Vehicle Model Chassis Type	Cyl. No.	Piston Ring					Remarks
				Position	Size (mm) d ₁ ×h ₁ ×a ₁ (D×B×T)	Material	Surface Treatment	Set Type	

統FUJI HEAVY INDUSTRIES, LTD. 富士重工業(株)

○——ガソリン車 Gasoline-engine Automobiles

※ (): OLD SET No.

EA71	1595	AC, AG, AN	4	1	92 × 1.2 × 3.3			SV	14070	12033-AA000
				2	92 × 1.5 × 3.7				(14060)	12033-AA330
				0	92 × 4 × 3.65					
EJ20	1994		4	1	92 × 1.2 × 3.3			SV	14241	12033-AA510
				2	92 × 1.5 × 3.7					
				0	92 × 3 × 3.1					
EJ22	2200	●Legacy	4	1	96.9 × 1.2 × 3.3			SV	14365	12033-AA210
				2	96.9 × 1.5 × 3.9					
				0	96.9 × 3 × 3.4					
EJ22	2200	●Legacy	4	1	96.9 × 1.5 × 3.3			SV	14790	12033-AA390
				2	96.9 × 1.5 × 3.9					12033-AA450
				0	96.9 × 3 × 3.4					12033-AA570
87B(EJ25)	2500		4	1	99.5 × 1.2 × 3.6			SV	14001	12033-AB340
				2	99.5 × 1.5 × 4					
				0	99.5 × 2 × 2.8					
EJ25	2500	●Legacy E-B99	4	1	99.5 × 1.2 × 3.6			SV	14355	12033-AA760
				2	99.5 × 1.5 × 4					
				0	99.5 × 2.8 × 3.4					
エンジン型式	排気量	車名・型式	シリンダー数	位置	サイズ 径×巾×厚さ	材質	表面改質	セットタイプ	セットNo.	備考
ピストンリング										

Engine Type	cc	Vehicle Model Chassis Type	Cyl. No.	Piston Ring						Remarks
				Position	Size (mm) d ₁ ×h ₁ ×a ₁ (D×B×T)	Material	Surface Treatment	Set Type	Set No. ※	

●HINO MOTORS, LTD. 日野自動車工業(株)

○——ディーゼル車 Diesel-engine Automobiles

※(): OLD SET No.

DM100	4313	●KM310, 330D, 350 ●Tractor HM300, HM301 ●Bus BM320	6	1	90 × 2.5 × 3.7			FO	15700	13011-1350A
				2	90 × 2.5 × 3.7					
				3	90 × 2.5 × 3.7					
				0	90 × 4 × 3.7					
				0	90 × 4 × 3.7					
DQ100	4507	●Truck KQ500, 520D, 540, 560, 500K, 540K KL501, 521D, 541, 561, 581, 501K, 541K, 561K KM500, 510, 520, 540	6	1	92 × 2.5 × 3.9	RN		FO	15650 (28650)	13011-1360
				2	92 × 2.5 × 3.9					
				3	92 × 2.5 × 3.9					
				0	92 × 4 × 3.9					
				0	92 × 4 × 3.9					
EC100	5010	●Truck KL300, 321D, 340, 360, 387A,300K,340K,360K, WB310, KL311, FD124 ●Tractor KJ300, HL300 ●Bus RL100, AM100	6	1	97 × 2.5 × 4.3	RN		FO	15470	13011-1390 13011-1400 13019-1140
				2	97 × 2.5 × 4.3					
				3	97 × 2.5 × 4.3					
				0	97 × 4 × 4.3	RN				
				0	97 × 4 × 4.3					
EC100	5010	●Truck KL300, 321D, 340, 360, 387A,300K,340K,360K, WB310, KL311, FD124 ●Tractor KJ300, HL300 ●Bus RL100, AM100	6	1	97 × 2.5 × 4.3	RN		FX	15030	
				2	97 × 2.5 × 4.3					
				3	97 × 2.5 × 4.3					
				0	97 × 4 × 3.1	RN				
				0	97 × 4 × 4.3					
W04C-T	4009	●Bus'84 ~ Rainbow RB145	4	1	104 × 2.8 × 4.3	RN		FX	15815	13011-2270 13011-2550 1ST=KEYSTONE
				2	104 × 2.5 × 4.3					
				0	104 × 5 × 3.2					
W04D	4009	●Ranger KM, FB112	4	1	104 × 2.5 × 4.3	RN	Cr4	FX	15011	13011-1973 13011-2540
				2	104 × 2 × 4.3					
				0	104 × 5 × 3.2					
W06D	5759	●Bus AC, FC42	6	1	104 × 2.5 × 4.3	RN	Cr4	FX	15010	13011-1983 13011-2420 13011-2440
				2	104 × 2 × 4.3					
				0	104 × 5 × 3.2					
W04D	4000	●Bus Riesse	4	1	104 × 2.5 × 3.6		GN	SM	15805	13011-78060
				2	104 × 2 × 4.3					
				0	104 × 4 × 2.5		GN			
DS70, DS90	7014	●Truck TE61, TE11, KL320, TE100, KL300 ●Tractor TE100D, TE100, 120 ●Bus RD100, 120, BK11, BT10, BT30, BT31	6	1	105 × 3 × 4.2			FO	15710	13011-1550A 13011-1210
				2	105 × 3 × 4.2					
				3	105 × 3 × 4.2					
				0	105 × 4.5 × 4.2					
				0	105 × 4.5 × 4.2					
エンジン型式	排気量	車名・型式	シリン ダー数	位置	サイズ 径×中×厚さ	材質	表面改質	セットタイプ	セットNo.	備考
ピストンリング										

Engine Type	cc	Vehicle Model Chassis Type	Cyl. No.	Piston Ring						Remarks
				Position	Size (mm) d ₁ ×h ₁ ×a ₁ (D×B×T)	Material	Surface Treatment	Set Type	Set No. ※	

統HINO MOTORS, LTD. 日野自動車工業(株)

○——ディーゼル車 Diesel-engine Automobiles

※(): OLD SET No.

EH100	5871	●Truck KL500, 540, 560, 580, 520, KR320, WB311, 321 ●Tractor KJ500, KU500, KR300, 350, KU580, 590 ●Bus BX320, AM101	6	1	105 × 2.5 × 4.3	RN		FO	15690	13011-1410 13011-1150
				2	105 × 2.5 × 4.3					
				3	105 × 2.5 × 4.3	RN				
				0	105 × 4 × 4.3					
				0	105 × 4 × 4.3					
EH100	5871	●Truck KL500, 540, 560, 580, 520, KR320, WB311, 321 ●Tractor KJ500, KU500, KR300, 360, KU580, 590 ●Bus BX320, AM101	6	1	105 × 2.5 × 4.3	RN		FX	15060	
				2	105 × 2.5 × 4.3					
				3	105 × 2.5 × 4.3	RN				
				0	105 × 4 × 3.1					
				0	105 × 4 × 4.3					
EH500	6211	●Truck Ranger 4S FD156AA	6	1	108 × 3 × 4.5	RN	Cr4	FX	15265	13011-1860A
				2	108 × 2.5 × 4.5					
				3	108 × 2.5 × 4.5	RN				
				0	108 × 5 × 3.2					
				0	108 × 5 × 3.2					
EH300	6211	●Truck KL301, 321, 361, KL501, KJ501, KU580 ●Bus RD300, RL300, 320	6	1	108 × 3 × 4.5	RN	Cr2	FX	15160	13011-1032 13011-1062
				2	108 × 2.5 × 4.5					
				0	108 × 5 × 3.2	RN				
				0	108 × 4 × 4.5					
				0	108 × 4 × 4.5					
H06C	6485	●GK, FD, RU	6	1	108 × 3 × 4.5	RN	Cr4	FX	15177	13011-2080 13011-2081B
				2	108 × 2.5 × 4.5					
				3	108 × 2.5 × 4.5	RN				
				0	108 × 5 × 3.2					
				0	108 × 5 × 3.2					
H06C-TA	6485	●Ranger F. D	6	1	108 × 2.806 × 4.5	RN		FX	15360	13011-1961 1ST=KEYSTONE
				2	108 × 2.5 × 4.5					
				3	108 × 2.5 × 4.5	RN				
				0	108 × 5 × 3.2					
				0	108 × 5 × 3.2					
H06C-T			6	1	108 × 2.8 × 4.5	RN		FM	15345	13011-3281 1ST=KEYSTONE
				2	108 × 2.5 × 4.5					
				3	108 × 2.5 × 4.5	RN				
				0	108 × 4 × 2.45					
				0	108 × 4 × 2.45					
DS50,60,80	7982	●Truck ZC34D, 44D ●Bus BT100H	6	1	110 × 3 × 4.5			FO	15730	13011-1230 13011-1261 13011-1830 13011-1680 13011-1650
				2	110 × 3 × 4.5					
				3	110 × 3 × 4.5					
				0	110 × 4.5 × 4.5					
				0	110 × 4.5 × 4.5					
エンジン型式	排気量	車名・型式	シリン ダー数	位置	サイズ 径×中×厚さ	材質	表面改質	セットタイプ	セットNo.	備考
ピストンリング										

Engine Type	cc	Vehicle Model Chassis Type	Cyl. No.	Piston Ring						Remarks
				Position	Size (mm) d ₁ ×h ₁ ×a ₁ (D×B×T)	Material	Surface Treatment	Set Type	Set No. ※	

統 HINO MOTORS, LTD. 日野自動車工業(株)

○——ディーゼル車 Diesel-engine Automobiles

※(): OLD SET No.

DS50,60,80	7982	●Truck ZC34D, 44D ●Bus BT100H	6	1	110 × 3 × 4.3	RN		FX	15120	13011-1250
				2	110 × 3 × 4.5					
				3	110 × 3 × 4.5					
				0	110 × 4.5 × 3.3	RN				
				0	110 × 4.5 × 4.5					
EH700	6443	●Truck KL545, KL585, KR365, KL525, KR305, LB595, KL555, KR325, KL565, FD171, 172, 174, 175, 476 ●Bus RJ170, 171, 172, RD300, 301, RL320	6	1	110 × 3 × 4.5	RN	Cr4	FX	15170	13011-1610 13011-1620 S1304-E0420
				2	110 × 2.5 × 4.5					
				3	110 × 2.5 × 4.5					
				0	110 × 5 × 3.2	RN				
H07C	6728	●Truck P-GD179BA, P-FF173BA ●Bus P-RJ170BA, P-RJ172BA	6	1	110 × 3 × 4.5	RN	Cr4	FX	15135 (15950)	13011-2070 13011-2090 13011-2900A 13011-3010A 13011-3020A
				2	110 × 2.5 × 4.5					
				3	110 × 2.5 × 4.5					
				0	110 × 5 × 3.2	RN				
H07C EH700				1	110 × 3 × 4.5		Cr4	FM	15173	
				2	110 × 2.5 × 4.5		Cr1			
				3	110 × 2.5 × 4.5		Cr1			
				0	110 × 5 × 2.6		Cr1			
H07C-T	6728	●Truck FD, FG, SD, RR	6	1	110 × 2.806 × 4.5	RN		FM	15167	13011-2672 1ST=KEYSTONE
				2	110 × 2 × 4.5	RN	Cr4			
				3	110 × 2.5 × 4.5					
				0	110 × 4 × 2.45					
H07C-T			6	1	110 × 2.806 × 4.5	RN		FM	15365	13011-3510 13011-3470A 1ST=KEYSTONE
				2	110 × 2 × 4.5	RN	Cr4			
				3	110 × 2 × 4.5	RN				
				0	110 × 4 × 2.45					
H07E	6728	●Truck P-GD179BA, P-EF173BA ●Bus P-RJ170BA, P-RJ172BA	6	1	110 × 3 × 4.5	RN		FX	15951	13011-3010 13011-3020 13011-3030A
				2	110 × 2.5 × 4.5					
				3	110 × 2.5 × 4.5					
				0	110 × 5 × 3.2	RN				
H07D	7412	FD, FC, GD FF, FT, RI	6	1	110 × 3 × 4.5	RN		FM	15920	13011-2650 13011-2651 13011-2660 S1304-E0450
				2	110 × 2 × 4.5	RN	Cr4			
				0	110 × 4 × 2.5					
J08E	7684	●Ranger	6	1	112 × 2.5 × 3.8		GN	SV	15015	13011-4040A
				2	112 × 2.0 × 4.1		GN			
				0	112 × 4.0 × 2.5		GN			
J07, J08C	7961	FD	6	1	114 × 3 × 4.5	RN		FM	15965	13011-2962 13011-2960 13011-2961
				2	114 × 2 × 4.5	RN	Cr4			
				0	114 × 4 × 2.45					
エンジン型式	排気量	車名・型式	シリン ダー数	位置	サイズ 径×中×厚さ	材質	表面改質	セットタイプ	セットNo.	備考
ピストンリング										

Engine Type	cc	Vehicle Model Chassis Type	Cyl. No.	Piston Ring						Remarks
				Position	Size (mm) d ₁ ×h ₁ ×a ₁ (D×B×T)	Material	Surface Treatment	Set Type	Set No.※	

統HINO MOTORS, LTD. 日野自動車工業(株)

○——ディーゼル車 Diesel-engine Automobiles

※(): OLD SET No.

J08, J6C	7961		6	1	114 × 2.5 × 4.3		GN GN	SM	15284	13011-3820		
				2	114 × 2 × 4.1					13011-3570		
				0	114 × 4 × 2.5					13011-3870 13011-3890B		
EB100, 200	9036	●Truck KB300D, KB320, 340, 360, KB380, 100, 120, 110, 301, KB312, 321, 341, 361, 381, KB111, KB121 ●Bus RE100, RE100-P, RE120, 140, RE120-P	6	1	115 × 3.5 × 4.7	RN		FO	15790	13011-1300		
				2	115 × 3 × 4.6					13011-1310		
				3	115 × 3 × 4.6					13011-1690		
				0	115 × 5 × 4.6			RN	FX	15140		
				0	115 × 5 × 4.5							
				0	115 × 5 × 4.5							
EL100T	7862	●Truck FG185, LB760	6	1	116 × 3 × 4.8	RN		FX	15190	13011-1700		
				2	116 × 2.5 × 4.8							
				3	116 × 2.5 × 4.8							
				0	116 × 5 × 3.2							
DK10T, 20T	10170	●Truck TC301, 311, 121, BG100 ●Bus RC300, 320, 300P, 320P, RC320PT ●Tractor HE100, HF300, HF301, HH700, HH720	6	1	120 × 3.5 × 4.6	RN		FO	15050	13011-1280		
				2	120 × 3.5 × 4.6					13011-1200		
				3	120 × 3.5 × 4.6					13011-1270		
				0	120 × 5 × 4.6			RN	RN			
				0	120 × 5 × 4.6							
				0	120 × 5 × 4.6							
DK10, 20	10170	●Truck TC301, 311, 121, BG100 ●Bus RC300, 320, 300P, 320P, RC320PT ●Tractor HE100, HF300, HF301, HH700, HH720	6	1	120 × 3.5 × 4.6	RN		FX	15150	13011-1290		
				2	120 × 3.5 × 4.6							
				3	120 × 3.5 × 4.6							
				0	120 × 5 × 3.3							
				0	120 × 5 × 4.6							
				0	120 × 5 × 4.6							
EB300	9838	●Truck KB113D, 122, 303D, 313, 314, 322, 342, 362, 720, 383, 392, E320, ZH100D, KB304D, KH120, BG100, KB394, 721, ZT300, 320 ●Bus RF400	6	1	120 × 3.5 × 4.6	RN		FX	15200	13011-1730		
				2	120 × 3.5 × 4.6					13011-1720		
				3	120 × 3.5 × 4.6					13011-1330		
				0	120 × 6 × 3.7					13011-1340		
				0	120 × 6 × 3.7							
EB400	9838	●Bus RE101, RE161, RE121, RE141	6	1	120 × 3.306 × 4.6	RN	Cr2	FX	15290	13011-1640A		
				2	120 × 3 × 4.6					13011-1630		
				3	120 × 3 × 4.6					13011-2330B		
				0	120 × 6 × 3.7					1ST=KEYSTONE		
				0	120 × 6 × 3.7							
エンジン型式	排気量	車名・型式	シリン ダー数	位置	サイズ 径×巾×厚さ	材質	表面改質	セットタイプ	セットNo.	備考		
ピストンリング												

Engine Type	cc	Vehicle Model Chassis Type	Cyl. No.	Piston Ring						Remarks
				Position	Size (mm) d ₁ ×h ₁ ×a ₁ (D×B×T)	Material	Surface Treatment	Set Type	Set No. ※	

統 HINO MOTORS, LTD. 日野自動車工業(株)

○——ディーゼル車 Diesel-engine Automobiles

※ (): OLD SET No.

EB400	9838	●Bus RE101, RE161, RE121, RE141	6	1	120 × 3.306 × 4.6	RN	Cr1	FX	15295	1ST=KEYSTONE
				2	120 × 3 × 4.6					
				3	120 × 3 × 4.6					
				0	120 × 6 × 3.7					
EP100	8821	●Super dolphin FN288 11.5ton	6	1	120 × 3.306 × 4.8	RN		FX	15245	13011-1952
				2	120 × 2.8 × 4.8	RN	Cr4			
				3	120 × 2.5 × 4.8					
				0	120 × 5 × 3.2					
EP100			6	1	120 × 3.3 × 4.8	RN		FX	15480	13011-2370A 13011-2760B
				2	120 × 3 × 4.8	RN	Cr4			
				3	120 × 2.5 × 4.8					
				0	120 × 5 × 2.9	RN				
P11C	10520	●Blue Ribbon ●Super Dolphin	6	1	122 × 3.306 × 4.4	RN		FM	15296	13011-3110A 13011-3111A 13011-3112A 13011-3114 13011-3800 1ST, 2ND=KEYSTONE
				2	122 × 2.3 × 4.8	RN				
				3	122 × 2 × 4.8	RN				
				0	122 × 4 × 2.45					
EM100	9419	●Truck FH288	6	1	124 × 2.806 × 5	RN		FX	15801 (15840)	13011-1931 13011-1921
				2	124 × 2.5 × 5	RN				
				3	124 × 3 × 5					
				0	124 × 5 × 3.5	RN				
M10U	9880	●Bus HT, HU	6	1	127 × 3.306 × 5.2	RN		FX	15033	13011-2860 13011-2870 13011-2250 1ST=KEYSTONE
				2	127 × 3 × 5.2	RN				
				3	127 × 3 × 5.4					
				0	127 × 5 × 3.5					
ED100	11581	●Truck KB500, TC302, 322, 342, 362, 382, 921, KF300D, 320, 340, 360, 380, 390, 355, 365, 385, HH130, ZH102, 8G150D, HE335, ZH110D, ZC120, ZG150D, ZR300, ZC150	6	1	128 × 3.5 × 4.8	RN		FX	15210 (15260)	13011-1470 13011-1670 13011-1660 13011-2240
				2	128 × 3.5 × 4.8	RN				
				3	128 × 3.5 × 4.8					
				0	128 × 6 × 3.7					
ED100		●Truck HT, HH	6	1	128 × 3.5 × 4.8	RN		FX	15110	13011-1480
				2	128 × 3.5 × 4.8					
				3	128 × 3.5 × 4.8					
				0	128 × 6 × 3.7					
ER200	11581	●Bus RC300, 301, 302, RC321, 381	6	1	128 × 3.306 × 4.8	RN		FX	15180	13011-1770
				2	128 × 3 × 4.8					
				3	128 × 3 × 4.8					
				0	128 × 6 × 3.7					
エンジン型式	排気量	車名・型式	シリン ダー数	位置	サイズ 径×中×厚さ	材質	表面改質	セットタイプ	セットNo.	備考
ピストンリング										

Engine Type	cc	Vehicle Model Chassis Type	Cyl. No.	Piston Ring					Remarks
				Position	Size (mm) d ₁ ×h ₁ ×a ₁ (D×B×T)	Material	Surface Treatment	Set Type	

統HINO MOTORS, LTD. 日野自動車工業(株)

○——ディーゼル車 Diesel-engine Automobiles

※(): OLD SET No.

EF100	13804	●Truck TC701D, 721, 741, 761, 781, KF702D, 722, 742, 762, 782, 792, 765, 785, ZM102D, 301D, 341, 703D, 743, 763, HE345, HH340, HK340, KA340, HF701D, HE340, HE345 ●Bus RV730P, RV750P	8	1	130 × 3.306 × 5.2	RN		FX	15080	13011-1570
				2	130 × 3.5 × 5.4					13011-1580
				3	130 × 3.5 × 5.4					13011-1590
				0	130 × 6 × 3.8					IST=KEYSTONE
EF100T	13804	●Truck HE340, HE345, HE346	8	1	130 × 3.306 × 5.2	RN		FX	15090	13011-1180
				2	130 × 3.5 × 5.4					IST=KEYSTONE
				3	130 × 3.5 × 5.4					
				0	130 × 6 × 3.8					
EF300,EF350	14232	●Truck TC702D, KF703D, ZM704D, KF797, ZM764, ZM705D, KF746, KF704, 706, 798, ZM765, KF767, KS341, ZM706, 765, 745 ●Bus RV761, RS120	8	1	132 × 3.306 × 5.2	RN		FX	15330	13011-1091
				2	132 × 3.5 × 5.4					13011-1100
				3	132 × 3.5 × 5.4					13011-1101
				0	132 × 6 × 3.8					IST=KEYSTONE
EF500 EG100	15459 14886	●Truck ZM500D, WP325, HE356, ZM560, KF585, ZM540, ZM580, TC921, TC541, 561B, HE350, 355, WB300, HE330 ●Bus RV541, RV561P, RS360P, RV530P, 540P, 550P	8	1	135 × 3.306 × 5.4	RN		FX	15340 (15970)	13011-1131
				2	135 × 3.5 × 5.4					13011-1141
				3	135 × 3.5 × 5.4					13011-1460
				0	135 × 6 × 3.8					13011-2150 13011-2160
EF550	16260	●Truck FS, FR, FN, SH, RU	8	1	135 × 3.306 × 5.4	RN	Cr4	FX	15241	13011-2010A
				2	135 × 3.5 × 5.4					13011-2700
				3	135 × 3.5 × 5.4					IST=KEYSTONE
				0	135 × 5 × 3					
K13C	12882	●Truck FS, FR, FN	6	1	135 × 3.306 × 5.4	RN	Cr4	FX	15465	13011-3090
				2	135 × 3.5 × 5.4					IST=KEYSTONE
				3	135 × 3.5 × 5.4					
				0	135 × 5 × 3					
EK100 EK200	13267	●Truck TC363, KF392, KS391, KS341, KB501D, KF301, 391, ZM303, TC922, ZR255, TC343, 362, WD300, TC383, ZC101, 121 ●Bus RC721P	6	1	137 × 3.306 × 5.4	RN		FX	15320	13011-1021
				2	137 × 3.5 × 5.4					13011-1010
				3	137 × 3.5 × 5.4					13011-1011
				0	137 × 6 × 3.8					IST=KEYSTONE
エンジン型式	排気量	車名・型式	シリン ダー数	位置	サイズ 径×中×厚さ	材質	表面改質	セットタイプ	セットNo.	備考
ピストンリング										

Engine Type	cc	Vehicle Model Chassis Type	Cyl. No.	Piston Ring						Remarks
				Position	Size (mm) d ₁ ×h ₁ ×a ₁ (D×B×T)	Material	Surface Treatment	Set Type	Set No. ※	

統 HINO MOTORS, LTD. 日野自動車工業(株)

○—ディーゼル車 Diesel-engine Automobiles

※(): OLD SET No.

EK100	13546	●Truck TC303D, KB501D, KF301D, KS321, ZM103D	6	1	137 × 3.306 × 5.4	RN		FX	15880	13011-2210
				2	137 × 3.5 × 5.4	RN				13011-2222
				3	137 × 3.5 × 5.4					
				0	137 × 6 × 3.8					1ST=KEYSTONE
D3EF750 EF700, 750	15920	●Truck HE366, HH341, TC562, ZM500, ZM940	8	1	137 × 3.306 × 5.4	RN		15230 (15350)	13011-1121, 1122	
				2	137 × 3.5 × 5.4				13011-1111, 1112	
				3	137 × 3.5 × 5.4				13011-2180,1121B	
				0	137 × 6 × 3.8				1ST=KEYSTONE	
EF700T,750T	16745	●Truck SH, SS, FN, FS, SH	8	1	137 × 3.306 × 5.4	RN		15870	13011-1890	
				2	137 × 3.306 × 5.4	RN			13011-1891	
				3	137 × 3.5 × 5.4				13011-3100B	
				0	137 × 6 × 3.8				1ST=KEYSTONE	
EF750	15920	●Truck ●Tractor HE, HH, TC	8	1	137 × 2.806 × 5.4	RN		15803	13011-1990	
				2	137 × 3.5 × 5.4					
				3	137 × 3 × 5.4					
				0	137 × 5 × 5				1ST=KEYSTONE	
EV700	19900	●Truck HE526, WP330, HH541, TC562	10	1	137 × 3.306 × 5.4	RN		15310 (15300)	13011-1741	
				2	137 × 3.5 × 5.4				13011-1751	
				3	137 × 3.5 × 5.4				13011-1740	
				0	137 × 6 × 3.8				1ST=KEYSTONE	
F17D	17238	●Truck FS, FR, RU FN, FW, SH	8	1	137 × 3.306 × 5.4	RN		15371	13011-2990	
				2	137 × 3.5 × 5.4	RN			13011-2991	
				3	137 × 3.5 × 5.4					
				0	137 × 5 × 3				1ST=KEYSTONE	
K13D	13260	●Super Dolphin	6	1	137 × 3.306 × 5.4	RN	Cr1	15800	13011-2970A	
				2	137 × 3.5 × 5.4	RN	Cr1			
				3	137 × 3.5 × 5.4		Cr1			
				0	137 × 5 × 3		Cr1		1ST=KEYSTONE	
F17-DTI	16745	●Tractor	8	1	137 × 3.306 × 5.4	RN	Cr1	15000	13011-3480A	
				2	137 × 3.5 × 5.4		Cr4		13019-1650A	
				3	137 × 3.5 × 5.4		Cr1			
				0	137 × 4 × 2.45		Cr1		1ST=KEYSTONE	
EK100	13267	●Super Dolphin	6	1	137 × 3.306 × 5.4	RN	Cr4	15016	13011-2221A	
				2	137 × 3.5 × 5.4					
				3	137 × 3.5 × 5.4		Cr1			
				0	137 × 6 × 3.8		Cr1		1ST=KEYSTONE	
F17C	17238	●Truck FS, FR, RU FN, FW, SH	8	1	139 × 3.306 × 5.4	RN		15420	13011-2810	
				2	139 × 3.5 × 5.5				13011-2820	
				3	139 × 3.5 × 5.5					
				0	139 × 5 × 3				1ST=KEYSTONE	
F17E	17238	●FS, FR, RU FN, FW, SH	8	1	139 × 3.306 × 5.4	RN		15381	13011-3150	
				2	139 × 3.5 × 5.5	RN			13011-3160	
				3	139 × 3.5 × 5.6					
				0	139 × 5 × 3				1ST=KEYSTONE	
エンジン型式	排気量	車名・型式	シリン ダー数	位置	サイズ 径×中×厚さ	材質	表面改質	セットタイプ	セットNo.	備考
ピストンリング										

Engine Type	cc	Vehicle Model Chassis Type	Cyl. No.	Piston Ring					Remarks
				Position	Size (mm) d ₁ ×h ₁ ×a ₁ (D×B×T)	Material	Surface Treatment	Set Type	

統HINO MOTORS, LTD. 日野自動車工業(株)

○——ディーゼル車 Diesel-engine Automobiles

※(): OLD SET No.

V22C	21548	●Truck SH, SS	10	1	139 × 3.306 × 5.4	RN		FX	15835	13011-2470
				2	139 × 3.5 × 5.5					13011-2471
				3	139 × 3.5 × 5.5					13011-2472
				0	139 × 6 × 3.8					13011-2472 IST=KEYSTONE
V22D	21548	●Truck SH, FS, FN	10	1	139 × 3.306 × 5.4	RN		FM	15391	13011-3180
				2	139 × 3.5 × 5.5	RN				13011-3080
				3	139 × 3.5 × 5.6					
				0	139 × 5 × 3					13011-3080 IST=KEYSTONE
EA100		●Bus	10	1	140 × 3.306 × 5	RN	Cr4	FX	15280	13011-1540
				2	140 × 3 × 5	RN				
				3	140 × 3 × 5					
				0	140 × 6 × 3	RN				13011-1540 IST=KEYSTONE
F20C	19688	●Truck FS, FR, FO, FN, FW, FY, SH, RU	8	1	146 × 3.306 × 5.6	RN		FM	15336	13011-2792A
				2	146 × 3.5 × 5.6	RN	Cr4			
				3	146 × 3.5 × 5.6	RN				
				0	146 × 5 × 3					13011-2792A IST=KEYSTONE
F20C-NEW	19688	●Truck	8	1	146 × 3.306 × 5.4	RN	Cr1	FM	15031	13011-3320A
				2	146 × 3 × 5.6		Cr4			13019-1720A
				3	146 × 3 × 5.7		Cr1			
				0	146 × 4 × 2.95		Cr1			13019-1720A IST=KEYSTONE
V25C	24610	●Super Dolphin	10	1	146 × 3.306 × 5.6	RN		FM	15335	13011-2980A
				2	146 × 3.5 × 5.6	RN	Cr4			13011-2981
				3	146 × 3.5 × 5.6					13011-3250
				0	146 × 5 × 5.25					
F21C	20781	●Selega ●Super Dolphin	8	1	150 × 3.287 × 5.8	RN		FM	15220	13011-3310A
				2	150 × 3 × 5.8		Cr4			
				3	150 × 3 × 5.7	RN				
				0	150 × 4 × 2.5					
V26C	25977	●Super Dolphin	10	1	150 × 3.306 × 5.5	RN		FM	15225	13011-3
				2	150 × 3 × 5.9		Cr4			
				3	150 × 3 × 5.9	RN				
				0	150 × 4 × 4.4					
エンジン型式	排気量	車名・型式	シリンダー数	位置	サイズ 径×巾×厚さ	材質	表面改質	セットタイプ	セットNo.	備考
ピストンリング										

Engine Type	cc	Vehicle Model Chassis Type	Cyl. No.	Piston Ring						Remarks
				Position	Size (mm) d ₁ ×h ₁ ×a ₁ (D×B×T)	Material	Surface Treatment	Set Type	Set No. ※	

●ISUZU MOTORS, LTD. いすゞ自動車工業(株)

○——ガソリン車 Gasoline-engine Automobiles

※(): OLD SET No.

4XC1-H	1471	●Gemini	4	1	77 × 1.2 × 2.8		GN	SV	17680	8-94162-769-0 8-94109-650-0/cyl.			
				2	77 × 1.2 × 3.5								
				0	77 × 2.8 × 3.1								
4XC1	1471	●JT151F	4	1	77 × 1.5 × 3	RN		FV	17006	8-94141-947 8-94141-948-0			
				0	77 × 2.8 × 3.1								
G150	1500	●Bellet PR20, PR40 ●Elf 1500	4	1	79 × 2 × 3.1			FV	17450	9-12181-055 9-12181-071			
				2	79 × 2 × 3.1								
				0	79 × 4 × 3.1								
G161A G161Z G161AB	1584	●Florian 1600 ●Elf ●Foster PA20V, KA41V, 51V	4	1	82 × 2 × 3.8			FV	17580	12181-055 9-12181-113-0 9-12181-141-0 8-94206-294-0 9-94216-639-0			
				2	82 × 2 × 3.8								
				0	82 × 4 × 3.9								
G161	1584	●PF50	4	1	82 × 1.5 × 3.8	RN RN		FV	17460	12181-101			
				2	82 × 1.5 × 3.8								
				0	82 × 4 × 3.9								
G161Z	1584	●PF50	4	1	82 × 1.5 × 3.3		RF	SV	17260	8-94244-403-0 8-94130-293-0 8-94452-743-1			
				2	82 × 1.5 × 3.7								
				0	82 × 4 × 3.2								
				1	82 × 1.5 × 3.3						Cr1	SV	17275
				2	82 × 1.5 × 3.7								
				0	82 × 4 × 3.2								
G161W	1584	●117 Coupe	4	1	82 × 2 × 3.8			FO	17240	9-12181-616-0			
				2	82 × 2 × 3.8								
				0	82 × 4 × 3.8								
GL201	1991	●Truck TLG21VC, TLG30, TLG30V, TLG50 ●Elf TLG11, TLG11V, TLG21, TLG60, TLG60D ●Elfin TKG11, TKG11W ●Bus BLG11, BLG20, TLG21B	4	1	83 × 2 × 3.4			FV	17430	9-12181-061-0			
				2	83 × 2 × 3.4								
				3	83 × 2 × 3.4								
				0	83 × 4 × 3.4								
				0	83 × 4 × 3.4								
DL201			4	1	83 × 2 × 3.4			FO	17520				
				2	83 × 2 × 3.4								
				3	83 × 2 × 3.4								
				0	83 × 4 × 3.4								
				0	83 × 4 × 3.4								
G180Z	1817		4	1	84 × 1.5 × 3.3			SV	17000	8-94244-404-0 8-94130-294-0			
				2	84 × 1.5 × 3.8								
				0	84 × 4 × 3.2								
G180	1818	●Florian 1800 ●Bellet 1800 117 Coupe PR60, PR95	4	1	84 × 2 × 3.8			FV	17570	9-12181-605-0 9-12181-615 8-94216-640-0 8-94208-205-0			
				2	84 × 2 × 3.8								
				0	84 × 4 × 3.9								
エンジン型式	排気量	車名・型式	シリン ダー数	位置	サイズ 径×中×厚さ	材質	表面改質	セットタイプ	セットNo.	備考			
ピストンリング													

Engine Type	cc	Vehicle Model Chassis Type	Cyl. No.	Piston Ring						Remarks
				Position	Size (mm) d ₁ ×h ₁ ×a ₁ (D×B×T)	Material	Surface Treatment	Set Type	Set No. ※	

統 ISUZU MOTORS, LTD. いすゞ自動車工業(株)

○——ガソリン車 Gasoline-engine Automobiles

※(): OLD SET No.

4ZB1	1817	●WFR11	4	1	84 × 1.5 × 3.6			SV	17290	8-94143-047-1			
				2	84 × 1.5 × 3.6								
				0	84 × 4 × 3.1								
			4	1	84 × 1.5 × 3.1	RN	GN	SV	17832	8-94313-195-0			
				2	84 × 1.5 × 3.5								
				0	84 × 4 × 3.1								
G190			4	1	85 × 3 × 3.5			FV	17831	1-19163-013-0			
				2	85 × 3 × 3.5								
				3	85 × 3 × 3.5								
				0	85 × 4 × 3.6								
G201	1951	●Bus BLG22, 22B, 24 ●Truck TLG12, 22, 32, 42, 52, 62, KVG20, 20VF ●For Agricultural Machine	4	1	86 × 2.5 × 4.1			FV	17480	9-12181-602-0			
				2	86 × 2.5 × 4.1								
				0	86 × 4 × 4.1								
22LE C22NE			4	1	86 × 1.5 × 3.5	RN	RF	FV	17545	8-92064-589-0			
				2	86 × 1.5 × 3.6								
				0	86 × 3 × 3.4								
G200Z	2000	●117 Coupe PA96	4	1	87 × 2 × 3.8			FV	17270	8-94216-641-0			
				2	87 × 2 × 3.8								
				0	87 × 4 × 3.8								
G200ZN	2000	●KB23, 28, 43, 48	4	1	87 × 1.5 × 3.3		RF	SV	17010	8-94231-817-0 8-94130-295-0			
				2	87 × 1.5 × 3.7								
				0	87 × 4 × 3.15								
				1	87 × 1.5 × 3.3						Cr1	SV	17007
				2	87 × 1.5 × 3.7								
				0	87 × 4 × 3.15								
D-MAX2.4	2400		4	1	87.5 × 1.2 × 3.1		GN	SV	17030	8-93359-241			
				2	87.5 × 1.5 × 3.7								
				0	87.5 × 2.5 × 3.1								
4ZC1	1994	●Aska	4	1	88 × 1.5 × 3.6			SV	17420	8-94235-878-0			
				2	88 × 1.5 × 3.8								
				0	88 × 4 × 3.1								
4ZD-1EXP	2254	●KGB29, 44, 49 TFR16 TFS16	4	1	89.3 × 1.5 × 3.3	RN	GN	SV	17670	8-94153-966-0 8-94136-778-0			
				2	89.3 × 1.5 × 3.8								
				0	89.3 × 4 × 3.1								
				1	89.3 × 1.5 × 3.3	RN	Cr1	SV			17675		
				2	89.3 × 1.5 × 3.8								
				0	89.3 × 4 × 3.1								
4ZE1	2600	●TFR17 TFS17	4	1	92.6 × 1.5 × 3.3		GN	SV	17590	8-94405-614-0 8-94446-957-1 8-94405-614-2			
				2	92.6 × 1.5 × 4								
				0	92.6 × 4 × 3.1								
				1	92.6 × 1.5 × 3.3		Cr1	SV			17595		
				2	92.6 × 1.5 × 4								
				0	92.6 × 4 × 3.1								
エンジン型式	排気量	車名・型式	シリン ダー数	位置	サイズ 径×巾×厚さ	材質	表面改質	セットタイプ	セットNo.	備考			
ピストンリング													

Engine Type	cc	Vehicle Model Chassis Type	Cyl. No.	Piston Ring					Remarks
				Position	Size (mm) d ₁ ×h ₁ ×a ₁ (D×B×T)	Material	Surface Treatment	Set Type	

統 ISUZU MOTORS, LTD. いすゞ自動車工業(株)

○——ガソリン車 Gasoline-engine Automobiles

※(): OLD SET No.

6VD1	3165	●BIG HONE UBS25GW	6	1	93.4 × 1.5 × 3.3	GN		SV	17983	8-97037-372-0
				2	93.4 × 1.5 × 4					
				0	93.4 × 3.9 × 3.1	GN				
エンジン型式	排気量	車名・型式	シリンダー数	位置	サイズ 径×巾×厚さ	材質	表面改質	セットタイプ	セットNo.	備考
ピストンリング										

Engine Type	cc	Vehicle Model Chassis Type	Cyl. No.	Piston Ring						Remarks
				Position	Size (mm) d ₁ ×h ₁ ×a ₁ (D×B×T)	Material	Surface Treatment	Set Type	Set No. ※	

統 ISUZU MOTORS, LTD. いすゞ自動車工業(株)

○——ディーゼル車 Diesel-engine Automobiles

※(): OLD SET No.

3KA1, 3KB1	877	●For industrial Machine	3	1	70 × 2 × 2.9	RN		FX	17001	8-94131-493-0				
				2	70 × 1.5 × 3.1									
				0	70 × 3.5 × 2.1									
3KC1		●For industrial Machine	3	1	74 × 2 × 2.9	RN		FX	17002	5-12121-031-0				
				2	74 × 1.5 × 3.1									
				0	74 × 3 × 2.1									
4EC1	1487	●Gemini Diesel JT6000	4	1	76 × 2 × 3.1	RN		FX	17600	8-94144-187-0 8-94332-767-1				
				2	76 × 1.5 × 3.1									
				0	76 × 3 × 2.1									
4EC1	1487	●Gemini FF	4	1	76 × 2 × 3.1	RN		FM	17985	8-94342-490-0				
				2	76 × 1.5 × 3									
				0	76 × 3 × 2									
4FB1	1487	●Gemini FF	4	1	76.3 × 2 × 3.3	RN	Cr4	FX	17185	8-94169-748-0				
				2	76.3 × 2 × 3.3									
				0	76.3 × 4 × 2.5									
4FE1			4	1	79 × 2 × 3.1			FX	17895	8-94381-709-0				
				2	79 × 1.5 × 3.3									
				0	79 × 3 × 2.5									
3AE1			3	1	80 × 2 × 3.5		Cr4	FX	17040	5-12121-011-0				
				2	80 × 2 × 3.5									
				0	80 × 4 × 3									
C220	2200	●Elf TLD11, TLD11D, TLD11V, TLD21, TLD31V, TLD21W, TLD60 ●Elfin TKD11, TKD11V, TKD11W ●Truck TLD21VC, TLD30, TLD30V, TLD50 ●Bus BLD11, BLD22, BLD11B, BLD21B	4	1	83 × 2 × 3.4			FX	17712	9-12181-100 9-12181-057 9-12181-062				
				2	83 × 2 × 3.4									
				3	83 × 2 × 3.4									
				0	83 × 4 × 3.4									
				0	83 × 4 × 3.4									
				0	83 × 4 × 3.4									
				0	83 × 4 × 3.4									
C221, C201 C201P(PT)	2200	●Elf TLD22V, TLD22, TLD12, TLD22W, TLD32, TLD22VF TLD52, TLD62 ●Bus BLD22	4	1	83 × 2 × 3.4		Cr3	FX	17861	9-12181-122-0 5-12181-015-0 5-12121-014-0 5-12121-013-0				
				2	83 × 2 × 3.4									
				3	83 × 2 × 3.4									
				0	83 × 5 × 2.8									
				0	83 × 5 × 3.2									
				0	83 × 5 × 3.2									
				1	83 × 2 × 3.4						Cr1	FX	17860	
				2	83 × 2 × 3.4									
				3	83 × 2 × 3.4									
				0	83 × 5 × 2.8									
0	83 × 5 × 3.2													
4FB1 4FC1	1817 1995	●Gemini Diesel PFD60 ●Fargo WFR51	4	1	84 × 2.5 × 3.5	RN	Cr4	FX	17650	8-94224-221-0 8-94139-973-0				
				2	84 × 2 × 3.5									
				0	84 × 4 × 2.8									
エンジン型式	排気量	車名・型式	シリン ダー数	位置	サイズ 径×巾×厚さ	材質	表面改質	セットタイプ	セットNo.	備考				
ピストンリング														

Engine Type	cc	Vehicle Model Chassis Type	Cyl. No.	Piston Ring						Remarks
				Position	Size (mm) d ₁ ×h ₁ ×a ₁ (D×B×T)	Material	Surface Treatment	Set Type	Set No. ※	

統 ISUZU MOTORS, LTD. いすゞ自動車工業(株)

○——ディーゼル車 Diesel-engine Automobiles

※(): OLD SET No.

4FB1 4FC1	1817 1995	●Gemini Diesel PFD60 ● Fargo WFR51	4	1	84 × 2.5 × 3.5	RN	Cr4	FX	17705					
				2	84 × 2 × 3.5									
				0	84 × 4 × 2.8									
C240, C190	2369	●Elf TDL13, 23, 23Z, 43, 53, 63, KVD20, 20VF, TLD23ZV, KAD51V, PAD30, PAD30V, KAD51ZV, KAD51NV, PAD96, KAD50NV, TLD23V, KAD41V ●Truck KAD41, 51, KUD20Z, TLD, TLD33, TLD23ZP, 23ZV, KAD52, 42, KBD40, 20, TCD23, KB40, 41, KBD20, 26	4	1	86 × 2 × 3.5		Cr3	FX	17511	12181-138				
				2	86 × 2 × 3.5					9-12181-138-0				
				3	86 × 2 × 3.5									
				0	86 × 5 × 2.8									
				0	86 × 5 × 3.5									
				0	86 × 5 × 3.5									
			C240(NEW) C190(NEW)	2369	●Bus BLD24, KAD51ZB, KAD51, KAD52, KVD20	4	1	86 × 2 × 3.5		Cr1	FX	17510		
							2	86 × 2 × 3.5						
							3	86 × 2 × 3.5						
							0	86 × 5 × 2.8						
0	86 × 5 × 3.5													
0	86 × 5 × 3.5													
2AB1	1184		2	1	86 × 2 × 3.5	RN	Cr4	FX	17350	5-12181-010-2				
				2	86 × 2 × 3.5					5-12121-010-0				
				3	86 × 2 × 3.5									
				0	86 × 5 × 3									
C240(NEW,NEW) C190(NEW,NEW)	2369 1951	●Elf 150 Elf 250	4	1	86 × 2.5 × 4			FX	17390	5-12121-021-0				
				2	86 × 2 × 3.5					8-94104-949-0				
				0	86 × 5 × 4.2									
C190	1951	●Elf 150	4	1	86 × 2.5 × 3.9	RN	Cr4	FX	17391	5-12121-022-0				
				2	86 × 2 × 3.5									
				0	86 × 5 × 3									
C190G	1951	●Florian VAN	4	1	86 × 2 × 3.5		Cr4	FX	17715	5-12121-008-0				
				2	86 × 2 × 3.5									
				3	86 × 2 × 3.5									
				0	86 × 5 × 3									
C240PKG			4	1	86 × 2.5 × 3.8			FX	17009	8-94471-442-0				
				2	86 × 2 × 3.5									
				0	86 × 5 × 2.9									
C223	2238	●RodeoTFR52 ●BighornTFS52 KRD22 ●117 Coupe Diesel TFS52, KRD22, TFR52	4	1	88 × 2 × 3.5			FX	17380	8-94253-736-0				
				2	88 × 2 × 3.5									
				0	88 × 4 × 2.7									
			4	1	88 × 2.5 × 3.9					RN	Cr4	FX	17400	5-12121-017-0
				2	88 × 2 × 4						Cr4			5-12121-024-0
				0	88 × 4.5 × 3									
C223T	2238	●TruckTFR FasterTFS Hi Pack Van	4	1	88 × 2.5 × 4		Cr3	FX	17970	8-94158-084-0				
				2	88 × 2 × 3.55									
				0	88 × 4 × 2.4									
4FD1	2189	●Rodio `83 Bighorn	4	1	88 × 2 × 3.5	RN		FX	17935	8-94250-730-0				
				2	88 × 2 × 3.6									
				0	88 × 4 × 2.4									
エンジン型式	排気量	車名・型式	シリン ダー数	位置	サイズ 径×巾×厚さ	材質	表面改質	セットタイプ	セットNo.	備考				
ピストンリング														

Engine Type	cc	Vehicle Model Chassis Type	Cyl. No.	Piston Ring						Remarks
				Position	Size (mm) d ₁ ×h ₁ ×a ₁ (D×B×T)	Material	Surface Treatment	Set Type	Set No.※	

統 ISUZU MOTORS, LTD. いすゞ自動車工業(株)

○—ディーゼル車 Diesel-engine Automobiles

※(): OLD SET No.

4FG1	2400	●WFR62	4	1	89.3 × 2 × 3.1			SX	17003	8-94469-634-0	
				2	89.3 × 2 × 3.8						
				0	89.3 × 4 × 2.7						
4JA-1 4JB-1	2499 2771	●KBD23, 28 TFR54, TFS54	4	1	93 × 2 × 4			FX	17490	8-94247-867-1	
				2	93 × 2 × 4						
				0	93 × 4 × 2.6						
D-MAX2.5	2500		4	1	93 × 2 × 4			FM	17031	8-97259-041	
				2	93 × 2 × 4						
				0	93 × 4 × 2.5						
D-MAX3.5	3500		6	1	93.4 × 1.2 × 3.5		GN	SM	17034	8-97371-553-0	
				2	93.4 × 1.2 × 3.8						
				0	93.4 × 2 × 2						
6VE1	3494	●Rodeo Sport	6	1	93.4 × 1.5 × 3.3			Cr1	SV	17014	8-97136-135-0
				2	93.4 × 1.5 × 4.0						
				0	93.4 × 3.0 × 2.8						
4JHI	3000	D-MAX 3.0	4	1	95.4 × 2.5 × 3.9			FM	17033	8-97259-941-0	
				2	95.4 × 2 × 3.7						
				0	95.4 × 3 × 2.5						
4JJ1TC 4JK1	3059	●D-MAX	4	1	95.4 × 2.0 × 3.5		GN	SM	17037	8-98096-676-0 8-97388-734-0 IST=HALF KEYSTONE	
				2	95.4 × 1.5 × 4.0						
				0	95.4 × 3.0 × 1.8						
4JG2	3059	●TC-IC O-UBS69GW	4	1	95.5 × 2.5 × 4			FM	17211	8-97080-215-0	
				2	95.5 × 2 × 4						
				0	95.5 × 4 × 2.5						
C330	3318	●Elf KS	4	1	98 × 3 × 3.9			Cr3	FX	17930	9-12181-801-0
				2	98 × 2.5 × 3.9						
				0	98 × 5 × 3						
D500	4978	●Foward TR, BY	6	1	98 × 3 × 3.9			Cr3	FX	17560	5-12181-020-0 9-12181-608-0
				2	98 × 2.5 × 3.9						
				0	98 × 5 × 3.2						
4BA1	2775	●Elf ●Truck TLD64, KS11, 21, 31, TLD64D, 34, 44, 54, 24, TLD23	4	1	98 × 3 × 3.9			Cr3	FX	17150	5-12181-025-0 12181-619 12181-601 5-12121-001 5-12121-019
				2	98 × 2.5 × 3.9						
				0	98 × 5 × 3						
DA120(Old)	6126	●Truck TX552, 552-T, TX551, 551-T, TX542, 542-D, 542-T, TX541, 541-D, 541-T, TS543, 543-D, TW542, 542D, TS540, TXD50, TSD40	6	1	100 × 2.5 × 4	RN	Cr4	FX	17740	9-12181-091-0 9-12181-063	
				2	100 × 2.5 × 4						
				3	100 × 2.5 × 4						
				0	100 × 4 × 2.9						
				0	100 × 4 × 4						
DA220(Old)	4084	●For Industrial Machine	4	1	100 × 2.5 × 4	RN	Cr4	FX	17750	9-12181-093-0	
				2	100 × 2.5 × 4						
				3	100 × 2.5 × 4						
				0	100 × 4 × 2.9						
				0	100 × 4 × 4						
エンジン型式	排気量	車名・型式	シリン ダー数	位置	サイズ 径×巾×厚さ	材質	表面改質	セットタイプ	セットNo.	備考	
ピストンリング											

Engine Type	cc	Vehicle Model Chassis Type	Cyl. No.	Piston Ring					Remarks
				Position	Size (mm) d ₁ ×h ₁ ×a ₁ (D×B×T)	Material	Surface Treatment	Set Type	

統 ISUZU MOTORS, LTD. いすゞ自動車工業(株)

○——ディーゼル車 Diesel-engine Automobiles

※(): OLD SET No.

DA120(New)	6126	●Bus BA341P, 343, 351, 541, 543, 551, BB341, 351, 551, BX352, 531, 552	6	1	100 × 2.5 × 4.2	RN	Cr2	FX	17320 (17790)	12181-005			
				2	100 × 2.5 × 4.4					12181-128			
				3	100 × 2.5 × 4.4					12181-036			
				0	100 × 5 × 3.3					12181-087			
		●For Industrial Machine	6		1	100 × 2.5 × 4.2	RN	Cr4	FX	17008			
					2	100 × 2.5 × 4.4							
					3	100 × 2.5 × 4.4							
					0	100 × 5 × 3.3							
DA220(New)	4084	●For Industrial Machine	4	1	100 × 2.5 × 4.2	RN	Cr2	FX	17330	18181-006			
				2	100 × 2.5 × 4.4					12181-038			
				3	100 × 2.5 × 4.4					12181-111			
				0	100 × 5 × 3.3								
							1	100 × 2.5 × 4.2	RN	Cr4	FX	17335	
							2	100 × 2.5 × 4.4					
							3	100 × 2.5 × 4.4					
							0	100 × 5 × 3.3					
DA640(Old)	6373	●Truck TXD70E, TXD80E	6	1	102 × 2.5 × 4	RN	Cr4	FX	17760	9-12181-092-0			
				2	102 × 2.5 × 4					12181-064-0			
				3	102 × 2.5 × 4					12181-048-0			
				0	102 × 4 × 2.9					12181-028-0			
		●Bus BA01, BA05, BA10, BA10P, BA20, BA20P, BS20, BF20	6		0	102 × 4 × 4							
					1	102 × 2.5 × 4.2	RN	Cr2	FX	17550	12181-033		
					2	102 × 2.5 × 4.4					12181-007		
					3	102 × 2.5 × 4.4					12181-074		
0	102 × 5 × 3.3				12181-110								
DA640(New) DA640PP	6373	●Truck TXD13, 23, 53, 60, SFR320, 420, 460, 500, 600, TSD43, TWD23	6	1	102 × 2.5 × 4.2	RN	Cr4	FX	17555 (17800)	12181-088			
				2	102 × 2.5 × 4.4								
				3	102 × 2.5 × 4.4								
				0	102 × 5 × 3.3								
		●Bus BA20, 20P, BF30	6		1	102 × 2.5 × 4.2	RN	Cr2	FX	17180	12181-014-1		
					2	102 × 2.5 × 4.4					12181-014-0		
					3	102 × 2.5 × 4.4					12181-035-0		
					0	102 × 5 × 3.3					12121-011/cyl. 1ST=KEYSTONE		
●Fork lift	6		1	102 × 3.5 × 4.2	RN		FX	17990	12181-014-1				
			2	102 × 2.5 × 4.4					12181-035-0				
			3	102 × 2.5 × 4.4					12121-011/cyl.				
			0	102 × 5 × 3.3					1ST=KEYSTONE				
4BB1 4BD1	3595 3856	●Elf ●Truck KS11, 21, 31, KS121D, KA31	4	1	102 × 3 × 4.4		Cr3	FX	17210	5-12181-024-1			
				2	102 × 2.5 × 4.4					5-12181-003			
				0	102 × 5 × 3.3					5-12121-005-0/cyl.			

エンジン型式	排気量	車名・型式	シリン ダー数	位置	サイズ 径×中×厚さ	材質	表面改質	セットタイプ	セットNo.	備考
--------	-----	-------	------------	----	------------	----	------	--------	--------	----

Engine Type	cc	Vehicle Model Chassis Type	Cyl. No.	Piston Ring						Remarks
				Position	Size (mm) d ₁ ×h ₁ ×a ₁ (D×B×T)	Material	Surface Treatment	Set Type	Set No. ※	

統 ISUZU MOTORS, LTD. いすゞ自動車工業(株)

○—ディーゼル車 Diesel-engine Automobiles

※(): OLD SET No.

6BD1 6BB1	5393	●Foward ●Truck SBR320, 380, 430, 450, 500, 560, 400, 680, YBR360, 310, SBR320D, 380D, 422, 322, 482, 552, FBR370, JBR, TLD23ZPO	6	1	102 × 3 × 4.4		Cr3	FX	17300	5-12181-023-2
				2	102 × 2.5 × 4.4					5-12121-055-0/cyl.
				0	102 × 5 × 3.3					5-12121-002/ CYL 5-12121-022/CYL
6BD1, MT	5785	●JCR360, JCR420, ●JCR480, JCR500	6	1	102 × 3.5 × 4.4			FX	17910	5-12121-051
				2	102 × 2.5 × 4.4					5-12121-015-0
				0	102 × 5 × 3.3					1ST=KEYSTONE
4BC1	3268	TRD46, 56 KT15, 25, 35, 45 NKR57 NPR57	4	1	102 × 3 × 4.4		Cr3	FX	17531	5-12121-004-0
				2	102 × 2.5 × 4.4					
				0	102 × 5 × 3.3					
4BD2			4	1	102 × 3 × 4.4		Cr4 GN GN	FM	17011	8-97117-686-0
				2	102 × 2 × 3.55					
				0	102 × 4 × 2.5					
4BE1	3636	●Elf NPR58	4	1	105 × 3 × 4.4		Cr3	FX	17980	8-94418-918-0
				2	105 × 2.5 × 4.5					
				0	105 × 5 × 3.4					
4BG1	4329	●Elf	4	1	105 × 3 × 4.4	RN	Cr4	FX	17515	8-94337-453-0
				2	105 × 2.5 × 4.6					
				0	105 × 4 × 3.1					
6BF1	6130	●Foward SDR370, SDR420, SDR422, SDR480, JDR460	6	1	105 × 3 × 4.4		Cr3	FX	17920	5-12121-006-0
				2	105 × 2.5 × 4.4					
				0	105 × 5 × 3.3					
6BG1-7C	6494	●Foward ●Truck	6	1	105 × 3.5 × 4.3	RN	Cr3	FX	17864	1-12121-115-0
				2	105 × 2.5 × 4.7					
				0	105 × 4 × 3.1					
6BG1	6500	●Foward FRS12 FTR12	6	1	105 × 3 × 4.5	RN	Cr3	FX	17004	1-12121-065-0
				2	105 × 2.5 × 4.5					
				0	105 × 4 × 3.4					
6BG1	6494	●Foward FRS12	6	1	105 × 3 × 4.4	RN	Cr3	FX	17536	1-12121-101-1
				2	105 × 2.5 × 4.6					
				0	105 × 4 × 3.1					
4HE1	4751	●Elf NPR	4	1	110 × 3 × 4.1		GN	SM	17685	8-97078-779-0
				2	110 × 2.5 × 4.7					
				0	110 × 4 × 2.5					1ST=HALF KEYSTONE
6HE1	7127	●Foward ●Truck	6	1	110 × 3 × 4.5	RN	Cr4	FM	17175	8-94396-840-0
				2	110 × 2.5 × 4.7					
				0	110 × 4 × 2.5					
4HF1	4334	●Elf NPR	4	1	112 × 3 × 4.5	RN	Cr4	FM	17863	8-97028-691-0
				2	112 × 2.5 × 4.7					
				0	112 × 4 × 2.5					
エンジン型式	排気量	車名・型式	シリン ダー数	位置	サイズ 径×中×厚さ	材質	表面改質	セットタイプ	セットNo.	備考
ピストンリング										

Engine Type	cc	Vehicle Model Chassis Type	Cyl. No.	Piston Ring						Remarks
				Position	Size (mm) d ₁ ×h ₁ ×a ₁ (D×B×T)	Material	Surface Treatment	Set Type	Set No. ※	

統 ISUZU MOTORS, LTD. いすゞ自動車工業(株)

○——ディーゼル車 Diesel-engine Automobiles

※(): OLD SET No.

4HF1	4334	●Forward ●Truck	4	1	112 × 3 × 4			SM	17481	8-97109-462-0
				2	112 × 2.5 × 4.7					
				0	112 × 4 × 2.5					
4HG1	4751	●Elf NPR	4	1	115 × 3 × 4.1	RN		SM	17915	8-97105-867-0
				2	115 × 2.5 × 4.8					
				0	115 × 4 × 2.5					
4HL1			4	1	115 × 3.0 × 4.1		Cr4 Cr1 GN	SM	17023	8-97331-641-0
				2	115 × 2.0 × 4.1					
				0	115 × 3.0 × 2.0					
6HH1	8226		6	1	115 × 3.5 × 4.5			FM	17975	8-94390-799-0
				2	115 × 2.5 × 4.8					
				0	115 × 4 × 2.5					
6HH1			6	1	115 × 3.5 × 4.5	RN	Cr4 Cr1 GN	FM	17027	8-94392-128-1
				2	115 × 2.5 × 4.8					
				0	115 × 3.0 × 2.0					
6HK1-TC	7790	●FORWARD FRR34,FSD34, FTR34,FTS34	6	1	115 × 2.948 × 4.3		Cr1 Cr1 GN	FM	17016	8-94391502-4
				2	115 × 2 × 4.3					
				3	115 × 2.5 × 4.8					
				0	115 × 3 × 3					
8PA1	9971	●Truck SKS390, SKW440, SKW520	8	1	115 × 3 × 4.6	RN	Cr4	FX	17060	1-12181-060-0
				2	115 × 2.5 × 4.8					
				0	115 × 6 × 3.7					
10PA1	12464	●Truck SRZ440, 441, 450, 451, 580, 650, VRR290, SPZ450D, SRM450D, SRM710, 701, SPK710, SRM450, 650, 680, 710, SRG720R, 750, TMK67Z, VRZ440, SRK701, 710, SRM441, 451, 651, ●Bus CRA580, 650	10	1	115 × 3 × 4.6	RN RN	Cr4	FX	17080	12181-016/cyl.
				2	115 × 2.5 × 4.8					
				0	115 × 6 × 3.7					
12PA1	14957	●Truck VRZ440, VTR290, VTZ440, VTR300	12	1	115 × 3 × 4.6	RN RN	Cr4	FX	17070	12181-016/cyl.
				2	115 × 2.5 × 4.8					
				0	115 × 6 × 3.7					
8PB1 10PB1 12PB1	11217 14022 16826	●Truck SMR, SMK, CSA, SSZ, VSR, VSZ, VVE, VVZ	8 10 12	1	115 × 3 × 4.6	RN RN	Cr4	FX	17110	1-12181-061-0/cyl. 1-12181-069/cyl.
				2	115 × 2.5 × 4.8					
				0	115 × 4 × 3.7					
6SA-T	8413	●Forward 200PS	6	1	115 × 3 × 4.6	RN RN	Cr4	FX	17005	1-12121-070-0 1-12121-075-0 1-12121-113-0
				2	115 × 2.5 × 4.8					
				0	115 × 4 × 2.6					
4HK	4751	●Elf	4	1	115 × 3 × 3.8			SM	17038	8-98040125-0
				2	115 × 2.5 × 4.8					
				0	115 × 4 × 2.5					
6SD1-X			6	1	117.9 × 3.5 × 4.9	RN RN	Cr4	FM	17478 (17470)	1-12121-090-0
				2	117.9 × 2.5 × 4.9					
				0	117.9 × 5 × 3					

エンジン型式	排気量	車名・型式	シリン ダー数	位置	サイズ 径×中×厚さ	材質	表面改質	セットタイプ	セットNo.	備考
--------	-----	-------	------------	----	------------	----	------	--------	--------	----

Engine Type	cc	Vehicle Model Chassis Type	Cyl. No.	Piston Ring						Remarks
				Position	Size (mm) d ₁ ×h ₁ ×a ₁ (D×B×T)	Material	Surface Treatment	Set Type	Set No. ※	

統 ISUZU MOTORS, LTD. いすゞ自動車工業(株)

○—ディーゼル車 Diesel-engine Automobiles

※(): OLD SET No.

6SD1MTC			6	1	117.9 × 4 × 4.9			FM	17845	1-12121-126-1
				2	117.9 × 3 × 4.5					
				3	117.9 × 3 × 4.9					
				0	117.9 × 4 × 2.5					
10PC1	15014	●Truck Bus	10	1	119 × 3 × 4.6	RN	Cr4	FX	17500	1-12121-047-0/cyl. 1-12121-048-0/CYL
				2	119 × 2.5 × 4.8					
				0	119 × 4 × 3.5					
10PC1-T 10PD1	15014	●CXM10.75ton Hi-Decker	10	1	119 × 4 × 4.6	RN	Cr4	FX	17501	1-12121-062-0/cyl. 1-12121-063-0/cyl.
				2	119 × 2.5 × 4.8					
				0	119 × 4 × 3.5					
DH100	10179	●Truck Bus TD50, TD60, TD70, TD80, TD90, TD141, TD161	6	1	120 × 3 × 5	RN	Cr4	FX	17770	12181-050 12181-068
				2	120 × 3 × 5					
				3	120 × 3 × 5					
				0	120 × 6 × 3.7					
				0	120 × 6 × 4.8					
DH100(New)	10179	●Truck TD50, 62, 72, SLR350P, 400, 450, 520, SLR600, 670, 700, VRB290, VLR290, TD50A-D, SLR360, 400T, 401 ●Bus BU04P, 10P, 15P, 20P, 35P, BU10, 20, 04, CLM500, BD40	6	1	120 × 3 × 5	RN	Cr4	FX	17810	1-12181-001-0 9-12181-083-0 9-12181-086-0 9-12181-114-0 12121-016-0/cyl
				2	120 × 3 × 5					
				3	120 × 3 × 5					
				0	120 × 6 × 3.5					
				0	120 × 6 × 3.5					
6SD1TC	9839	●Truck CXG23	6	1	120 × 3 × 4.9	RN	Cr4	FM	17370	1-12121-077-0
				2	120 × 2.5 × 4.9					
			6	0	120 × 5 × 3			FM	17655	1-12121-119-2
				1	120 × 4 × 4.9					
				2	120 × 3 × 4.5					
6SD1X	9839	●Foward CXG23	6	1	120 × 3.5 × 4.9		Cr4	FM	17660 (17668)	1-12121-094-1
				2	120 × 2.5 × 4.9					
				0	120 × 5 × 2.6					
				0	120 × 5 × 2.6					
6SD1			6	1	120 × 3 × 4.1		GN	SM	17012	1-12121149-0
				2	120 × 2 × 4.1					
				3	120 × 3 × 4.9					
				0	120 × 3 × 2.5					
6UZ1	9839	●GIGA CVR77,CXE77, CXM77,CXZ77	6	1	120 × 2.5 × 4.3		GN	SM	17013	8-98056-464-0
				2	120 × 2 × 4.1					
				3	120 × 3 × 4.9					
				0	120 × 3 × 2.5					
6QA1	11044	●Truck Bus TDJ50,TDJ72,TDJ78,CVR14, SJR361, DJR530,CJM470	6	1	125 × 3 × 5.1	RN	Cr4	FX	17190	1-12121-046 1-12121-028
				2	125 × 2.5 × 5.1					
				0	125 × 6 × 3.5					
エンジン型式	排気量	車名・型式	シリン ダ―数	位置	サイズ 径×中×厚さ	材質	表面改質	セットタイプ	セットNo.	備考
ピストンリング										

Engine Type	cc	Vehicle Model Chassis Type	Cyl. No.	Piston Ring						Remarks
				Position	Size (mm) d ₁ ×h ₁ ×a ₁ (D×B×T)	Material	Surface Treatment	Set Type	Set No. ※	

統 ISUZU MOTORS, LTD. いすゞ自動車工業(株)

○——ディーゼル車 Diesel-engine Automobiles

※(): OLD SET No.

D920	9203	●Truck TD11E, 51, 51A, 51E, 61, 70, 71, 71E, 75E, 81E, 91E, ●Bus BU04D,10D, D15D, 20D, 35D, BU04DP, 110DP, 15DP,	6	1	125 × 3 × 5.1	RN	Cr4	FX	17840	9-12181-115-0
				2	125 × 3 × 5.2					12121-021
				3	125 × 3 × 5.2					9-12181-108-0
				0	125 × 6 × 3.8					9-12181-143-0
D920-1	9203	●20DP, 35DP	6	1	125 × 3 × 5.1	RN	Cr4	FX	17020	9-12181-137-0
				2	125 × 2.5 × 5.1					
				0	125 × 6 × 3.8					
E110	11044	●Truck TM05E, 15E, 55ZED, 65, 65D, 65ZD, 85E, 95E, TG55E, 75E ●Bus BU05E, 10E, 15E, 20E ●Tractor TD35E	6	1	125 × 3 × 5.1	RN	Cr4	FX	17870	9-12181-153-0
				2	125 × 3 × 5.2					12121-022
				3	125 × 3 × 5.2					9-12181-143-0
				0	125 × 6 × 3.8					
6QB2	11780	●LV324L	6	1	125 × 4 × 4.8	RN	Cr4	FX	17200	1-12121-096-0/cyl.
				2	125 × 2.5 × 5.1					
				0	125 × 6 × 3.2					
6WA1-7C	12068	●GIGA	6	1	132.9 × 4.306 × 5.2	RN		FX	17143	1-12121-117-0
				2	132.9 × 3 × 5.2					
				3	132.9 × 3 × 5.5					
				0	132.9 × 5 × 3.8					
6WA T-C	12068	●GIGA	6	1	132.9 × 3.765 × 5.1		Cr1	SM	17690	1-12121-141-0/cyl.
				2	132.9 × 3 × 5.2					
				3	132.9 × 3 × 5.5					
				0	132.9 × 4 × 2.5					
E120	12023	●Truck SPR520, SPG470D, SPG540, 650, 720, 580, TMK48Z, 67Z, 68, 78, SPM450D, 550, 650, 710, SPD440D, 450, 580, 480, 650, SPK650, 710	6	1	135 × 4 × 5.3	RN		FX	17890	9-12181-149-0
				2	135 × 2.5 × 5.5					1-12121-023-0
				3	135 × 2.5 × 5.5					9-12181-144-0
				0	135 × 7 × 4.1					9-12181-144-1
E120(New)	12023	●Truck VPR290, VPZ440, TDK46, VPZ490, SPM701,710,SPZ, 451 ●Bus 30KP, 35KP, BU4K, 10K, 15K, 20K, 35K, BU04KP, 10KP, 15KP, 20KP, 35KP	6	1	135 × 4 × 5.5	RN		FX	17050	1-12181-022-0
				2	135 × 2.5 × 5.5					1-12181-034-0
				0	135 × 7 × 4.1					1-12181-024-0/cyl.
										1-12121-015-0/cyl.
6RA1, 2 6RB1, 2	12023 13741	●Truck SHM, CXM	6	1	135 × 4 × 5.5	RN		FX	17230	1-12121-037
				2	135 × 2.5 × 5.5					1-12121-040
				0	135 × 5 × 4.2					
エンジン型式	排気量	車名・型式	シリン ダー数	位置	サイズ 径×中×厚さ	材質	表面改質	セットタイプ	セットNo.	備考
ピストンリング										

Engine Type	cc	Vehicle Model Chassis Type	Cyl. No.	Piston Ring					Remarks
				Position	Size (mm) d ₁ ×h ₁ ×a ₁ (D×B×T)	Material	Surface Treatment	Set Type	

統 ISUZU MOTORS, LTD. いすゞ自動車工業(株)

○——ディーゼル車 Diesel-engine Automobiles

※(): OLD SET No.

6RBX	13741	●Truck CXM10 75ton L320PS	6	1	135 × 4 × 5.5	RN		FX	17834	1-12121-078-2
				2	135 × 2.5 × 5.5	RN				
				0	135 × 5 × 4.2					
8MA1	16513	●Truck SWG590, VWZ430, VWR340	8	1	145 × 4 × 5.9	RN	Cr4	FX	17535 (17040)	1-12121-018-0
				2	145 × 3 × 5.9	RN				
				0	145 × 6 × 2.9					

ISUZU MOTORS, LTD.
いすゞ自動車工業(株)

エンジン型式	排気量	車名・型式	シリン ダ―数	位置	サイズ 径×巾×厚さ	材質	表面改質	セットタイプ	セットNo.	備考
--------	-----	-------	------------	----	------------	----	------	--------	--------	----

Engine Type	cc	Vehicle Model Chassis Type	Cyl. No.	Piston Ring						Remarks
				Position	Size (mm) d ₁ ×h ₁ ×a ₁ (D×B×T)	Material	Surface Treatment	Set Type	Set No. ※	

●MITSUBISHI MOTORS CORP. 三菱自動車工業(株)

○——ガソリン車 Gasoline-engine Automobiles

※(): OLD SET No.

4A30,30T			4	1	60 × 1 × 2.1			SV	20325	MD301853 MD301870	
				2	60 × 1.2 × 2.6						
				0	60 × 2.5 × 2.5						
2G10 2G10-2	359	●Minica-2G-10-2 A101, T131, 131V	2	1	62 × 2.5 × 2.6	RN		FN	20390	MT205535 IST=HALF KEYSTONE	
				2	62 × 2.5 × 2.8						
				3	62 × 2.5 × 2.8						
2G21	359	●Minica-2G, 21 A103, 102	2	1	62 × 1.5 × 2.8			FV	20290	MD016765	
				2	62 × 1.5 × 2.8						
				0	62 × 2.5 × 3.2						
2G22	471	●Minica-2G, 22	2	1	65 × 1.5 × 2.8			FV	20980	MD019470	
				2	65 × 1.5 × 2.8						
				0	65 × 2.5 × 2.8						
3G82	660	●Minica	3	1	65 × 1.5 × 2.3		GN	SV	20003	MD120081	
				2	65 × 1.5 × 2.9						
				0	65 × 2.8 × 2.5		GN				
3G83	660	●Minica E-H22, H22A, V-H22V, V-U41T, 41V, V-U42T	3	1	65 × 1.2 × 2.3			SV	20892	MD160195	
				2	65 × 1.2 × 2.9						
				0	65 × 2.8 × 2.5						
4G11	1244	●Lancer ●Colt A151A, A155A, A171A	4	1	69.5 × 1.5 × 3.1			FV	20050 (21280)	MD030350 MD031670	
				2	69.5 × 1.5 × 3.1						
				0	69.5 × 4 × 3.1						
2G23	550	●Minica 55 ●Mini Cab Wide 55	2	1	70 × 1.5 × 3.1			FV	20380 (21380)	MD019610	
				2	70 × 1.5 × 3.1						
				0	70 × 2.5 × 2.8						
				1	70 × 1.5 × 2.9				SV	20060 (21210)	MD011965
				2	70 × 1.5 × 3.1						
				0	70 × 2.5 × 2.9						
4G42	1200	●Lancer1200 Colt1200 A71, 71V, H-71V	4	1	71 × 2 × 3.3	RN		FV	20080 (21390)	MD010850	
				2	71 × 2 × 3.3						
				0	71 × 4 × 3.4						
G13-H	1298	●Lancer	4	1	71 × 1.5 × 3.1			FV	20440 (21001)	MD074687 MD078543	
				2	71 × 1.5 × 3.1						
				0	71 × 4 × 3.4						
G13-H New	1298	●Mirage, Lancer	4	1	71 × 1.5 × 3.1		Cr4	FV	20490 (21002)	MD074687 MD078543 MD115490	
				2	71 × 1.5 × 3.1						
				0	71 × 4 × 3.4						
4G13(New)	1298	●Lancer	4	1	71 × 1.2 × 2.6			SV	20004 (21004)	MD158908	
				2	71 × 1.5 × 3.1						
				0	71 × 3 × 2.8						
		●Lancer ●Mirage	4	1	71 × 1.2 × 2.6		GN	SV	20965	MD335422	
				2	71 × 1.5 × 2.9						
				0	71 × 2.8 × 2.5						GN
4G17		●Mirage Colt	4	1	72.2 × 1.2 × 2.5			GN	SV	20292	MD165325
				2	72.2 × 1.5 × 3.1						
				0	72.2 × 3 × 2.8						
エンジン型式	排気量	車名・型式	シリンダー数	位置	サイズ 径×中×厚さ	材質	表面改質	セットタイプ	セットNo.	備考	
ピストンリング											

Engine Type	cc	Vehicle Model Chassis Type	Cyl. No.	Piston Ring						Remarks
				Position	Size (mm) d ₁ ×h ₁ ×a ₁ (D×B×T)	Material	Surface Treatment	Set Type	Set No. ※	

統 MITSUBISHI MOTORS CORP. 三菱自動車工業(株)

○——ガソリン車 Gasoline-engine Automobiles

※(): OLD SET No.

4G30 4G33(Old)	1289	●Colt-Galant A51, 51H, 51V ●Colt-Lancer A72, 72V, B-A72, H-A72V ●Colt-Galant A62, 55C	4	1	73 × 2 × 3.3			FV	20350	MD000770
				2	73 × 2 × 3.3					
				0	73 × 4 × 3.3					
4G33(New)	1439	●Lancer	4	1	73 × 1.5 × 3.3			FV	20500 (21550)	MD009625 MD034010 MD115500
				2	73 × 1.5 × 3.3					
				0	73 × 4 × 3.1					
6G34	1994	●Colt-Galant A57C,115A,115H, C-H57C,C-A115A ●Debonair 31	6	1	73 × 2 × 3.2			FV	20230	MD662060
				2	73 × 2 × 3.2					
				0	73 × 4 × 3.1					
4G12B	1410	●Mirage 12H, 12U, 12T	4	1	74 × 1.5 × 3.3			FV	20910	MD030355 MD031700 MD012025 MD012035
				2	74 × 1.5 × 3.3					
				0	74 × 4 × 3.3					
4G31B	1500	●Mirage C18A ●Hyundai 23433-31500	4	1	74.5 × 1.5 × 3.1			SV	20157	MD107368
				2	74.5 × 1.5 × 3.3					
				0	74.5 × 4 × 3.1					
NCC-3A9			4	1	75 × 1 × 2.3		GN	SV	21014	MN195612
				2	75 × 0.8 × 2.5					
				0	75 × 2 × 1.9					
4A91	1499	●Lancer	4	1	75 × 1.2 × 2.5		GN	SV	20065	1110C722
				2	75 × 0.8 × 2.5					
				0	75 × 2.0 × 1.9					
G15B, G15H, G15C	1468	●C12A C52A C62A	4	1	75.5 × 1.5 × 3.3			FV	20520 (21003)	MD074725 MD078548 MD104656
				2	75.5 × 1.5 × 3.3					
				0	75.5 × 4 × 3.1					
4G15(New)	1468	●Lancer, Mirage ●Lancer, Mirage R-CB2V	4	1	75.5 × 1.2 × 2.8		Cr1	SV	20630 (21005)	
				2	75.5 × 1.5 × 3.3					
				0	75.5 × 3 × 2.8					
				1	75.5 × 1.2 × 2.8	GN	SV	20670 (21006)	MD158549 MD180804	
				2	75.5 × 1.5 × 3.3					
				0	75.5 × 3 × 2.8	GN	SV	20999	MD333896 MD332715	
				1	75.5 × 1.2 × 2.8					
2	75.5 × 1.5 × 3.1									
0	75.5 × 2.8 × 2.5	GN								
2G24	548	●MINICA	2	1	76 × 1.5 × 3.2			SV	20640	MD018280
				2	76 × 1.5 × 3.3					
				0	76 × 2.5 × 2.9					
4G18-2 4G18		●PROTON WAJA	4	1	76 × 1.2 × 2.7		GN	SV	20007	MD361982 MD349422
				2	76 × 1.2 × 3.2					
				0	76 × 2.5 × 2.5					
エンジン型式	排気量	車名・型式	シリン ダー数	位置	サイズ 径×中×厚さ	材質	表面改質	セットタイプ	セットNo.	備考
ピストンリング										

Engine Type	cc	Vehicle Model Chassis Type	Cyl. No.	Piston Ring						Remarks
				Position	Size (mm) d ₁ ×h ₁ ×a ₁ (D×B×T)	Material	Surface Treatment	Set Type	Set No. ※	

統 MITSUBISHI MOTORS CORP. 三菱自動車工業(株)

○——ガソリン車 Gasoline-engine Automobiles

※(): OLD SET No.

4G18		●WAJA ●GENII	4	1	76 × 1.2 × 2.9			SV	20160	PW891185
				2	76 × 1.2 × 3.1					
				0	76 × 2.5 × 2.8					
4G18		●GENII	4	1	76 × 1.2 × 2.7		GN	SV	20056	
				2	76 × 1.5 × 3.3					
				0	76 × 2.5 × 2.5					
4G18	1600	●Lancer	4	1	76 × 1.2 × 2.8		GN	SV	20540	MD349422
				2	76 × 1.2 × 3.2					
				0	76 × 2.5 × 2.5					
4G41	1378	●Galant ●Delica A61, T120C, 120W, H-T120	4	1	76.5 × 2 × 3.5			FV	20690 (21120)	MD010715 MD011893 MD010710
				2	76.5 × 2 × 3.5					
				0	76.5 × 4 × 3.7					
4G32	1597	●Colt-Galant A53, 53C, 53V, 53H, 112A, 112C, B-A112A, 112H, 112V ●Colt-Lancer A73, 63, B-A73	4	1	76.9 × 2 × 3.5	RN		FV	20210	MD004709 MD106741 MD004739 MD008105 MD000725 MD005885 MD004770
				2	76.9 × 2 × 3.5					
				0	76.9 × 4 × 3.1					
4G32-2	1597		4	1	76.9 × 2 × 2.9		GN	SV	20953	MD110632
				2	76.9 × 2 × 3.4					
				0	76.9 × 4 × 3.1					
4G32-T	1597	●Cordia A161A	4	1	76.9 × 1.5 × 3.3			SV	20550	MD012765 MD062387 MD099430 MD093337
				2	76.9 × 1.5 × 3.4					
				0	76.9 × 4 × 3.6					
2G25	660	●MINICA	2	1	78 × 1.5 × 3.2			SV	20650	MD083152
				2	78 × 1.5 × 3.3					
				0	78 × 2.5 × 2.9					
4G91	1496	●Mirage	4	1	78.4 × 1.2 × 3.1			SV	20700 (21815)	MD177113
				2	78.4 × 1.2 × 3.3					
				0	78.4 × 2.8 × 2.6					
6A12	2000	●PROTON PERDANA	6	1	78.4 × 1.2 × 3.05			SV	20205	MD189104
				2	78.4 × 1.2 × 3.3					
				0	78.4 × 2.8 × 2.65					
4G62	1795	●Galant Σ ●Lancer A162, A175	4	1	80.6 × 2 × 3.5	RN		FV	20680	MD040610 MD106736
				2	80.6 × 2 × 3.7					
				0	80.6 × 4 × 3.1					
4G62T	1795	●Galant	4	1	80.6 × 1.5 × 3.3			SV	20681	MD040465
				2	80.6 × 1.5 × 3.7					
				0	80.6 × 4 × 3.1					
4G37	1755	●Galant	4	1	80.6 × 1.5 × 3.3		Cr4	SV	20530	MD077113 MD106028
				2	80.6 × 1.5 × 3.6					
				0	80.6 × 4 × 3.4					
4G37, 4G62	1800	●E-E12A	4	1	80.6 × 1.5 × 3.3		GN	SV	20875	MD154012
				2	80.6 × 1.5 × 3.7					
				0	80.6 × 4 × 3.1					

MITSUBISHI MOTORS CORP.
三菱自動車工業株

エンジン型式	排気量	車名・型式	シリン ダ数	位置	サイズ 径×中×厚さ	材質	表面改質	セットタイプ	セットNo.	備考
--------	-----	-------	-----------	----	------------	----	------	--------	--------	----

Engine Type	cc	Vehicle Model Chassis Type	Cyl. No.	Piston Ring						Remarks
				Position	Size (mm) d ₁ ×h ₁ ×a ₁ (D×B×T)	Material	Surface Treatment	Set Type	Set No. ※	

統 MITSUBISHI MOTORS CORP. 三菱自動車工業(株)

○——ガソリン車 Gasoline-engine Automobiles

※(): OLD SET No.

4G92	1600	●E-CA4A	4	1	81 × 1.2 × 3.1		GN	SV	20740 (21825)	MD173211			
				2	81 × 1.2 × 3.5					MD173206			
				0	81 × 2.8 × 2.65								
4G51	1855	●Galant Σ1850	4	1	81 × 2 × 3.5	RN		FV	20560 (21560)	MD023060			
				2	81 × 2 × 3.7								
				0	81 × 4 × 3.7								
4G94	2000	●Pajero i/o ●Lancer	4	1	81.5 × 1.2 × 2.7		GN	SV	20062	MD371157			
				2	81.5 × 1.2 × 3.4					MD371189			
				0	81.5 × 2.5 × 2.5		GN			MN183585			
									MN187179				
									1110B098				
									1110B099				
									1110B100				
4G61	1595	●Mirage	4	1	82.3 × 1.2 × 3.1		GN	SV	20787 (21787)	MD133495			
				2	82.3 × 1.5 × 3.8								
				0	82.3 × 3 × 2.9								
4G52	1955	●Galant Σ2000	4	1	84 × 2 × 3.6	RN		FV	20810 (21570)	MD021070			
				2	84 × 2 × 3.7					MD027010			
				0	84 × 4 × 3.75					MD021010			
4G63B-T	1997	●Galant Σ ●Shariot ●Pajero	4	1	85 × 1.5 × 3.3		GN	SV	20820 (21221)	MD105516			
				2	85 × 1.5 × 3.8					MD100467			
				0	85 × 4 × 3.1								
										Cr1	SV	20840 (21222)	
				1	85 × 1.5 × 3.3								
				2	85 × 1.5 × 3.8								
0	85 × 4 × 3.1												
4G63	1197	●Galant ΣA ●Galant Σ Van E-P03V, E-N13W, E-N33W	4	1	85 × 2 × 3.6	RN		FV	20920 (21220)	MD040640			
				2	85 × 2 × 3.7					MD041580			
				0	85 × 4 × 3.1					MD040840			
	1997	●Galant Shariot E-N13W	4	1	85 × 1.2 × 3.1		GN	SV	20652	MD195810			
				2	85 × 1.5 × 3.8								
				0	85 × 2.8 × 2.5		GN						
				4	1	85 × 1.2 × 3.1			SV	20651	MD195805		
					2	85 × 1.5 × 3.8							
					0	85 × 2.8 × 2.5							
	1997	●E-N33W, E-CD9A	4	1	85 × 1.2 × 3.1		GN	SV	20049 (21049)	MD195850			
				2	85 × 1.5 × 3.8								
				0	85 × 3 × 2.5		GN						
4G63EX	1997	●E-N33W, E-CD9A	4	1	85 × 1.2 × 3.1		GN	SV	20657	MD133485			
				2	85 × 1.5 × 3.8								
				0	85 × 3 × 2.8		GN						
4G63	1997		4	1	85 × 1.2 × 3.1		GN	SV	20659	MD313405			
				2	85 × 1.5 × 3.8								
				0	85 × 2.8 × 2.5		GN						
4G63 GDI	1997	●DION	4	1	85 × 1.2 × 3.1		GN	SV	20270	MD370449			
				2	85 × 1.2 × 3.5								
				0	85 × 2 × 2.2								
エンジン型式	排気量	車名・型式	シリン ダー数	位置	サイズ 径×巾×厚さ	材質	表面改質	セットタイプ	セットNo.	備考			
ピストンリング													

Engine Type	cc	Vehicle Model Chassis Type	Cyl. No.	Piston Ring						Remarks
				Position	Size (mm) d ₁ ×h ₁ ×a ₁ (D×B×T)	Material	Surface Treatment	Set Type	Set No. ※	

統 MITSUBISHI MOTORS CORP. 三菱自動車工業(株)

○——ガソリン車 Gasoline-engine Automobiles

※(): OLD SET No.

4B10 4B11	1798 1998	●Lancer ●Galant	4	1	86 × 1.2 × 3.1		Cr1	SV	20091	1110A436
				2	86 × 1.2 × 3.4					
				0	86 × 2 × 2.2					
4G64B	2350	●Delica wagon E-P04W	4	1	86.5 × 1.5 × 3.5			SV	20085 (21085)	MD085346
				2	86.5 × 1.5 × 3.8					
				0	86.5 × 4 × 3.4					
4G64K	2350	●Delica wagon E-P04W	4	1	86.5 × 1.2 × 3.1			SV	20155	MD195872
				2	86.5 × 1.5 × 3.8					
				0	86.5 × 3 × 2.5					
4G64	2350	●Delica wagon E-P04W	4	1	86.5 × 1.2 × 3.1		GN	SV	20291	MD192815
				2	86.5 × 1.5 × 3.8					
				0	86.5 × 2.8 × 2.5		GN			MD194597
4G64-S4			4	1	86.5 × 1.2 × 3.1			SV	20654	MD195828
				2	86.5 × 1.5 × 3.8					
				0	86.5 × 2.8 × 2.5					
4G69	2378	●Lancer ●Galant Fortis ●Grandis ●Eclipse ●Airtrek	6	1	87 × 1.2 × 3.1		Cr1	SV	20066	1110A966
				2	87 × 1.2 × 3.3					
				0	87 × 2 × 2.2					
6B31	2998	●Outlander ●Pajero sports	6	1	87.6 × 1.2 × 3.1		GN	SV	20094	1110B435
				2	87.6 × 1 × 2.9					
				0	87.6 × 2 × 2.2					
4G53	2384	●Canter ●Jeep FC211 BC211, J16, J38, J56	4	1	88 × 2 × 3.8	RN		FV	20950 (21620)	MD025000
				2	88 × 2 × 4.1					
				0	88 × 4 × 3.7					MD026985
4B12	2359	●Outlander ●DelicaD:5	4	1	88 × 1.2 × 3.3		Cr1	SV	20095	1110A822
				2	88 × 1.2 × 3.6					
				0	88 × 2 × 2.2					
4G54	2555	●Devonair ●Jeep	4	1	91.1 × 2 × 3.5	RN	Cr4	FV	20990 (21230)	MD026960
				2	91.1 × 2 × 3.8					
				0	91.1 × 4 × 3.45					
	●Devonair	4	1	91.1 × 2 × 3.3		GN	SV	20231 (21231)	MD107818	
			2	91.1 × 2 × 3.8						
			0	91.1 × 4 × 3.1						GN
4G64T 4G54T	2550	●Starion	4	1	91.1 × 1.5 × 3.6			SV	20998 (21998)	MD061258
				2	91.1 × 1.5 × 3.8					
				0	91.1 × 4 × 3.4					MD076170
エンジン型式	排気量	車名・型式	シリンダー数	位置	サイズ 径×中×厚さ	材質	表面改質	セットタイプ	セットNo.	備考
ピストンリング										

Engine Type	cc	Vehicle Model Chassis Type	Cyl. No.	Piston Ring					Remarks
				Position	Size (mm) d ₁ ×h ₁ ×a ₁ (D×B×T)	Material	Surface Treatment	Set Type	

統 MITSUBISHI MOTORS CORP. 三菱自動車工業(株)

○——ガソリン車 Gasoline-engine Automobiles

※(): OLD SET No.

6G72	2972	●Devonair S12A	6	1	91.1 × 1.5 × 3.3			SV	20006 (21621)	MD101895
				2	91.1 × 1.5 × 3.8					MD104922
				0	91.1 × 4 × 3.45					MD104923
										MD129548
										MD104939
										MD104940
6G74	3500	●Devonair	6	1	91.1 × 1.2 × 3.3		GN	SV	20793	MD301803
				2	91.1 × 1.5 × 3.8					MD165949
				0	91.1 × 3 × 2.8	GN				
6G74	3500	●Devonair	6	1	93 × 1.5 × 3.5		GN	SV	20018	MD300569
				2	93 × 1.5 × 3.9					MD369575
				0	93 × 3 × 2.8	GN				
6G75	3800	●Pajero ●Endeavor	6	1	95 × 1.2 × 3.6	RN	GN	SV	20063	MN176859
				2	95 × 1.2 × 3.5					
				0	95 × 2 × 2.5	GN				
エンジン型式	排気量	車名・型式	シリンダー数	位置	サイズ 径×巾×厚さ	材質	表面改質	セットタイプ	セットNo.	備考
ピストンリング										

Engine Type	cc	Vehicle Model Chassis Type	Cyl. No.	Piston Ring						Remarks
				Position	Size (mm) d ₁ ×h ₁ ×a ₁ (D×B×T)	Material	Surface Treatment	Set Type	Set No. ※	

統 MITSUBISHI MOTORS CORP. 三菱自動車工業(株)

○—ディーゼル車 Diesel-engine Automobiles

※(): OLD SET No.

4DQ3			4	1	77 × 2 × 3.3			FX	20936	30417-61010
				2	77 × 2 × 3.3					
				0	77 × 4 × 2.7					
4DQ			4	1	77 × 2 × 3.3			FX	20020	30417-51010
				2	77 × 2 × 3.3					
				0	77 × 2 × 2.7					
4D65,4D65T	1795	●Mirage, Galant Colt C14A	4	1	80.6 × 2 × 3.1	RN	GN	SX	20531	MD127022 MD127017 MD071206 IST=HALF KEYSTONE
				2	80.6 × 2 × 3.6					
				0	80.6 × 4 × 2.4					
				1	80.6 × 2 × 3.1	RN	Cr1	SX	20245 (21245)	IST=HALF KEYSTONE
				2	80.6 × 2 × 3.6					
				0	80.6 × 4 × 2.4					
4D65T	1795	●Galant ●Mirage, Galant Colt C14A	4	1	80.6 × 2 × 3.5	RN	RF	FM	20645 (21645)	MD136692 MD078209 MD078309 IST=HALF KEYSTONE
				2	80.6 × 2 × 3.5	RN				
				0	80.6 × 4 × 2.4					
				1	80.6 × 2 × 3.5	RN	Cr1	FM	20655 (21655)	IST=HALF KEYSTONE
				2	80.6 × 2 × 3.5	RN				
				0	80.6 × 4 × 2.4					
4DQ1	1986	●Bus MB720 ●Jupiter T720, T720D, T722	4	1	82 × 2 × 3.6			FX	20701	30617-01014
				2	82 × 2 × 3.6					
				3	82 × 2 × 3.6					
				0	82 × 4 × 2.8					
4D68T	1998		4	1	82.7 × 2 × 3.1	RN	GN	SM	20525	MD197187 1ST,2ND= HALF KEYSTONE
				2	82.7 × 2 × 3.5		RF			
				0	82.7 × 3 × 2		GN			
4D68NA	1998	●Galant RVR S-CB8V, X-CB8A, X-CB8W, X-F57A	4	1	82.7 × 2 × 3.5	RN	RF	FM	20973 (21973)	MD197162 IST=HALF KEYSTONE
				2	82.7 × 2 × 3.9					
				0	82.7 × 3 × 2		GN			
4DQ5	2084	●Canter	4	1	84 × 2.5 × 3.6	RN		FX	20250	30617-51011
				2	84 × 2 × 3.6					
				0	84 × 4 × 3.3					
				1	84 × 2.5 × 3.6	RN	Cr4	FX	20261 (21261)	30617-61011 IST=HALF KEYSTONE
				2	84 × 2 × 3.6					
				0	84 × 4 × 3.3					
4DR1	2384	●Canter New	4	1	88 × 2.5 × 3.6	RN	RF	FX	20450	30317-11011
				2	88 × 2 × 3.8					
				3	88 × 2 × 3.8					
				0	88 × 4 × 3.9					
4D55	2346	●Galant A167 Galant Sapporo	4	1	91.1 × 2.5 × 3.7	RN	RF	FX	20211	MD050395
				2	91.1 × 2 × 3.8	RN				
				0	91.1 × 4 × 2.7					
				1	91.1 × 2.5 × 3.7	RN		FX	20215	
				2	91.1 × 2 × 3.8					
				0	91.1 × 4 × 2.7					

エンジン型式	排気量	車名・型式	シリン ダ数	位置	サイズ 径×巾×厚さ	材質	表面改質	セットタイプ	セットNo.	備考
--------	-----	-------	-----------	----	------------	----	------	--------	--------	----

Engine Type	cc	Vehicle Model Chassis Type	Cyl. No.	Piston Ring					Remarks
				Position	Size (mm) d ₁ ×h ₁ ×a ₁ (D×B×T)	Material	Surface Treatment	Set Type	

統 MITSUBISHI MOTORS CORP. 三菱自動車工業(株)

○—ディーゼル車 Diesel-engine Automobiles

※(): OLD SET No.

4D55-T 4D56	2346	●Galant A167 ●L300, L038P, 68P	4	1	91.1 × 2.5 × 3.7	RN		FX	20503	MD050390			
				2	91.1 × 2 × 3.8	RN				MD103391			
				0	91.1 × 4 × 2.7					1ST,2ND= HALF KEYSTONE			
4D56TDI	2476	●Pajero ●Triton	4	1	91.1 × 2.5 × 3.3		Cr1	SM	20076	1110A561			
				2	91.1 × 1.98 × 3.7	RN	Cr1						
				0	91.1 × 4.0 × 2.5		GN			1ST=HALF KEYSTONE			
4D56	2476	●Pajero ●Triton	4	1	91.1 × 2.5 × 3.3		Cr1	SM	20083	1110B977			
				2	91.1 × 1.98 × 3.7	RN	Cr1						
				0	91.1 × 3.0 × 2.0		GN			1ST=HALF KEYSTONE			
4D55-2	2346	●Galant R167	4	1	91.1 × 2.5 × 3.7	RN	RF	FM	20685	MD168293			
				2	91.1 × 1.94 × 3.7	RN							
				0	91.1 × 4 × 2.5		GN			1ST=HALF KEYSTONE			
4DR52T-1	2659	●Canter	4	1	92 × 2.306 × 3.6	RN		FM	20835	ME996069			
				2	92 × 2 × 3.5	RN							
				0	92 × 4 × 2.5					1ST,2ND=KEYSTONE			
4DR-5	2659	●Canter T96A, 96B, 96A2, 98A, 98B, 98A2, 98B2, 98AD, 200F, 200C, 200CP, 200CT, 210F, 210C, 210CD, 210CT, 220, FE100, 120	4	1	92 × 2.5 × 3.7	RN		FX	20009 (21720) (21310)	31617-02013			
				2	92 × 2 × 3.9								
				3	92 × 2 × 3.9								
				0	92 × 4.5 × 3.2	RN							
				●Canter T96A, 96B, 98A, 98B, 200C, ●Bus B200, 210	4	1	92 × 2.5 × 3.7	RN			FX	20032	ME999073
						2	92 × 2 × 3.9						
0	92 × 4.5 × 3.2	RN					1ST=HALF KEYSTONE						
●Canter T96A, 96B, T200C, T200F ●Jeep J24, J36, J44 ●Rosa B200, B210	4	1	92 × 2.5 × 3.7			FX	20995	31617-02012					
		2	92 × 2 × 3.9										
		0	92 × 4.5 × 3.2					1ST=HALF KEYSTONE					
6DR-5	3988	●Jupiter T44A, 44B, 44C ●Bus B360, BH212, 215	6	1	92 × 2.5 × 3.7	RN		FX	20012 (21730)	31717-12013			
				2	92 × 2 × 3.9					31717-12012			
				3	92 × 2 × 3.9								
				0	92 × 4.5 × 3.2	RN				1ST=HALF KEYSTONE			
S4ES	2609		4	1	94 × 2.5 × 3.9	RN	Cr4	FX	20013 (21022)	34417-02012			
				2	94 × 2 × 3.9								
				0	94 × 4.5 × 3.2					1ST=HALF KEYSTONE			
S4E, S4S	2609		4	1	94 × 2.5 × 3.9	RN		FX	20014 (21540)	34417-11011			
				2	94 × 2 × 3.9								
				0	94 × 4.5 × 3.2	RN				1ST=HALF KEYSTONE			
4DR7			4	1	95 × 2.306 × 3.7	RN		FM	20957 (21045)	ME997256			
				2	95 × 2.306 × 3.7								
				0	95 × 4 × 3.9					1ST=KEYSTONE			
エンジン型式	排気量	車名・型式	シリン ダー数	位置	サイズ 径×中×厚さ	材質	表面改質	セットタイプ	セットNo.	備考			
ピストンリング													

Engine Type	cc	Vehicle Model Chassis Type	Cyl. No.	Piston Ring						Remarks
				Position	Size (mm) d ₁ ×h ₁ ×a ₁ (D×B×T)	Material	Surface Treatment	Set Type	Set No. ※	

統 MITSUBISHI MOTORS CORP. 三菱自動車工業(株)

○—ディーゼル車 Diesel-engine Automobiles

※(): OLD SET No.

6DS1	4678	●Truck T62D, 650B, 650E 650J, 650ZD ●Bus MR620	6	1	95 × 2.5 × 4.1	RN		FX	20320	ME021376 ME020382 30617-01006
				2	95 × 2 × 4.1					
				3	95 × 2 × 4.1					
				0	95 × 4.5 × 3					
6DS3	5103	●Truck T652B, 652E ●Bus B622B	6	1	95 × 3 × 3.9	RN		FX	20015 (21170)	ME023327 ME021855 IST=HALF KEYSTONE
				2	95 × 2 × 4.1					
				0	95 × 4.5 × 3					
4M40	2835	●Pajero FB501, FD511	4	1	95 × 2.3 × 3.35	RN	GN	SM	20661	MD997894 ME202380 IST=KEYSTONE
				2	95 × 2 × 4					
				0	95 × 4 × 2.5		GN			
4M40NA	2835	●Pajero	4	1	95 × 2.306 × 3.3	RN	GN	SM	20975	ME202950 IST=KEYSTONE
				2	95 × 2 × 3.7					
				0	95 × 4 × 2.4					
4M40-TC	2835	●Pajero	4	1	95 × 2.306 × 3.3	RN	GN	SM	20585	ME202148 IST=KEYSTONE
				2	95 × 2 × 4		Cr1			
				0	95 × 3 × 4.2		GN			
6DS5	4978	●Truck T630B, 651E ●Bus B620B, 620E, 620BE ●Tractor T651ZR	6	1	98 × 3 × 4.2	RN		FX	20330	ME021856 ME021382 ME020427 30817-31000
				2	98 × 2 × 4.2					
				3	98 × 2 × 4.2					
				0	98 × 5 × 3.3					
S4E2	2960		4	1	98 × 3 × 4	RN	Cr2	FX	20961	34417-09012 IST=HALF KEYSTONE
				2	98 × 2 × 4.2					
				0	98 × 5 × 3.5					
6DS5	4978	●Truck T630B, 651E ●Bus B620B, 620E, 620BE	6	1	98 × 3 × 4.2			FX	20590	
				2	98 × 2 × 4.2					
				3	98 × 2 × 4.2					
				0	98 × 5 × 3.3					
6DS7	5430	●Truck T653B, 653BG, 663C, 663ZD, FK102 ●Tractor T653ZR ●Bus B623B, 623E	6	1	98 × 3 × 4	RN		FX	20180 (21180)	ME024409 ME023333 ME021861 IST=HALF KEYSTONE
				2	98 × 2 × 4.2					
				0	98 × 5 × 3.3					
4M41T	3200	●Pajero ●Triton	4	1	98.5 × 2.3 × 3.3		GN	SM	20040	ME203533
				2	98.5 × 1.5 × 3.55					
				0	98.5 × 3 × 2					
4D30	3298	●Truck Canter ●Bus BE211	4	1	100 × 3 × 4	RN	Cr2	FX	20460 (21460)	ME012070 ME012010 IST=HALF KEYSTONE
				2	100 × 2 × 4.2					
				0	100 × 5 × 3.5					
				1	100 × 3 × 4	RN	Cr1	FX	20016 (21070)	IST=HALF KEYSTONE
				2	100 × 2 × 4.2					
				0	100 × 5 × 3.5					
エンジン型式	排気量	車名・型式	シリンダー数	位置	サイズ 径×中×厚さ	材質	表面改質	セットタイプ	セットNo.	備考
ピストンリング										

Engine Type	cc	Vehicle Model Chassis Type	Cyl. No.	Piston Ring						Remarks
				Position	Size (mm) d ₁ ×h ₁ ×a ₁ (D×B×T)	Material	Surface Treatment	Set Type	Set No. ※	

統 MITSUBISHI MOTORS CORP. 三菱自動車工業(株)

○—ディーゼル車 Diesel-engine Automobiles

※(): OLD SET No.

4D31T	3298	●Truck FE434 Canter	4	1	100 × 3 × 4	RN	Cr2	FM	20441	ME997396
				2	100 × 2 × 4.2					ME997398
				0	100 × 4 × 2.5					ME999783
										ME012848
										IST=HALF KEYSTONE
				1	100 × 3 × 4	RN	Cr1	FM	20405	
				2	100 × 2 × 4.2					
				0	100 × 4 × 2.5					IST=HALF KEYSTONE
6D31A	4948	●Truck FK330	6	1	100 × 3 × 4	RN	Cr2	FM	20431	ME999836
				2	100 × 2 × 4.2					
				0	100 × 4 × 2.5					IST=HALF KEYSTONE
				1	100 × 3 × 4	RN		FM	20435	
				2	100 × 2 × 4.2					
				0	100 × 4 × 2.5					IST=HALF KEYSTONE
6D31T	4948	●Truck FK330, FE434	6	1	100 × 3 × 4	RN	Cr2	FM	20445	ME997458
				2	100 × 2 × 4	RN				
				0	100 × 4 × 2.5					IST=HALF KEYSTONE
				1	100 × 3 × 4	RN	Cr1	FM	20008	
				2	100 × 2 × 4	RN				
				0	100 × 4 × 2.5					IST=HALF KEYSTONE
		●Truck FK330	6	1	100 × 3 × 4	RN	Cr2	FX	20761 (21761)	ME999717
				2	100 × 2 × 4					
				0	100 × 5 × 3.5					IST=HALF KEYSTONE
S6KT	6380		6	1	102 × 3 × 4	RN	Cr2	FX	20955 (21955)	34317-19010
				2	102 × 2 × 4.2	RN				
				0	102 × 4 × 2.8					IST=HALF KEYSTONE
				1	102 × 3 × 4	RN	Cr1	FX	20005	
				2	102 × 2 × 4	RN				
				0	102 × 4 × 2.8					IST=HALF KEYSTONE
4D34	3907	●Truck FE439	4	1	104 × 3 × 4.1	RN		FM	20941	ME997237
				2	104 × 2 × 4.2					
				0	104 × 4 × 2.5					
4D34T	3907	●Truck BE449, 459 FE439	4	1	104 × 2.806 × 4.1	RN		FM	20931	ME997240
				2	104 × 2 × 4.2					
				0	104 × 4 × 2.5					IST=KEYSTONE
			4	1	104 × 2.8 × 3.6		GN	SM	20615	ME996566
				2	104 × 2 × 4					
				0	104 × 4 × 2.5					IST=KEYSTONE
4D32	3567	●Truck FE305, 315, 435	4	1	104 × 3 × 4.1	RN	Cr2	FX	20940	ME999243
				2	104 × 2 × 4.2					
				0	104 × 4 × 3.2	RN				IST=HALF KEYSTONE
				1	104 × 3 × 4.1	RN	Cr1	FX	20475	ME999243/cyl.
				2	104 × 2 × 4.2					
				0	104 × 4 × 3.2					IST=HALF KEYSTONE
エンジン型式	排気量	車名・型式	シリンダー数	位置	サイズ 径×中×厚さ	材質	表面改質	セットタイプ	セットNo.	備考
ピストンリング										

Engine Type	cc	Vehicle Model Chassis Type	Cyl. No.	Piston Ring						Remarks
				Position	Size (mm) d ₁ ×h ₁ ×a ₁ (D×B×T)	Material	Surface Treatment	Set Type	Set No. ※	

⑧ MITSUBISHI MOTORS CORP. 三菱自動車工業(株)

○ ———— ディーゼル車 Diesel-engine Automobiles

※ (): OLD SET No.

4D32	3567	●Truck FE305, 315, 435	4	1	104 × 3 × 4.1	RN	Cr2,Cr3	FM	20942	ME997318		
				2	104 × 2 × 4.2							
				0	104 × 4 × 2.5						IST=HALF KEYSTONE	
				1	104 × 3 × 4.1	RN	Cr1	FM	20946			
				2	104 × 2 × 4.2							
				0	104 × 4 × 2.5						IST=HALF KEYSTONE	
				1	104 × 3 × 4.1	RN	Cr4	FM	20515	ME997318/cyl.		
				2	104 × 2 × 4.2							
				0	104 × 4 × 2.5						IST=HALF KEYSTONE	
				1	104 × 3 × 4.1	RN	Cr2,Cr3	FX	20017 (21981)	ME999641		
				2	104 × 2 × 4.2							
				0	104 × 4 × 3.2	RN					IST=HALF KEYSTONE	
				1	104 × 3 × 4.1	RN	Cr4	FX	20485			
				2	104 × 2 × 4.2							
				0	104 × 4 × 3.2	RN					IST=HALF KEYSTONE	
6D34 6D34T			6	1	104 × 2.8 × 4.1	RN		FM	20935	ME996442		
				2	104 × 2 × 4.2							
				0	104 × 4 × 2.5						IST=KEYSTONE	
6D34T			6	1	104 × 2.8 × 3.7			SM	20620	ME993488		
				2	104 × 2 × 4	RN						
				0	104 × 4 × 2.5						IST=KEYSTONE	
6D10, 11	6754	●Track T654B, T654ZR, FK10-3, KK103 ●Bus MK103H, MM504H	6	1	105 × 3 × 4.2	RN		FX	20023 (21190)	ME032190		
				2	105 × 2 × 4.4						ME032326	
				0	105 × 5 × 3.5	RN					IST=HALF KEYSTONE	
4D33	4214	●Truck FE437, 447	4	1	108 × 3 × 4.3	RN		FX	20021	ME999871		
				2	108 × 2 × 4.4							
				0	108 × 4 × 2.9	RN						
				1	108 × 3 × 4.3	RN	Cr2	FM	20099	ME996378		
				2	108 × 2 × 4.4							
				0	108 × 4 × 2.5							
				1	108 × 3 × 4.3	RN	Cr1	FM	20022			
				2	108 × 2 × 4.4							
				0	108 × 4 × 2.5							
4D35	4561	●Canter FE538, FE638	4	1	110 × 3 × 4.3	RN		FM	20845 (21845)	ME996628		
				2	110 × 2.5 × 4.4						ME995237	
				0	110 × 4 × 3							
			●Canter	4	1	110 × 3 × 3.9			SM	20150	ME995214	
					2	110 × 2 × 3.9						
					0	110 × 4 × 2.95						
エンジン型式	排気量	車名・型式	シリンダー数	位置	サイズ 径×中×厚さ	材質	表面改質	セットタイプ	セットNo.	備考		
ピストンリング												

Engine Type	cc	Vehicle Model Chassis Type	Cyl. No.	Piston Ring					Remarks
				Position	Size (mm) d ₁ ×h ₁ ×a ₁ (D×B×T)	Material	Surface Treatment	Set Type	

統 MITSUBISHI MOTORS CORP. 三菱自動車工業(株)

○—ディーゼル車 Diesel-engine Automobiles

※(): OLD SET No.

DB31	8550	●Truck T32, 33, 52, 320, 330, 330T, 330D, 335T, 335D, 335, 350, 370, 370D, 380, 385, W11D, AT33, 330, 330T ●Bus R470, 480, MR440, 470, 480, 490, MAR440, 470, 480, 490, B360, 370, 380	6	1	110 × 4 × 4	RN		FX	20722	30017-02002
				2	110 × 4 × 4					
				3	110 × 4 × 4					
				0	110 × 5 × 4.2					
				0	110 × 5 × 4.2					
DB34	8550	●Truck T340, 390 ●Bus R470, 480, AR470, 480, MR430, 440, 480, 490, MAR440, 470, 480	6	1	110 × 2.5 × 4.7			FO	20730	30017-31004
				2	110 × 2.5 × 4.7					
				3	110 × 2.5 × 4.7					
				0	110 × 4.5 × 4.7					
				0	110 × 4.5 × 4.7					
6DB	8550	●Truck T416, 486, 410D, 331, 337D ●Bus B820J, MR520, 410, 470, 450, MAR410, 470	6	1	110 × 3.5 × 4.4	RN		FX	20024 (21600)	30017-75003 30017-71003
				2	110 × 2.5 × 4.7					
				3	110 × 2.5 × 4.7	RN		FX	21440 (20110)	30017-75002 30017-73002
				0	110 × 5 × 3.8					
6D14	6557	●Track FK115F, 115H, 115J 115K, T656ZR, FK115DR, FM215, FK115 ●Bus MK115H, MK115, MM115, 515	6	1	110 × 3 × 4.3	RN		FX	20025 (21610)	ME032458 ME032260 ME032404 ME032071 IST=HALF KEYSTONE
				2	110 × 2.5 × 4.4					
				0	110 × 5 × 3.8					
6D14T	6557	●Truck FK615, FK415, 515	6	1	110 × 3 × 4.3	RN		FX	20026 (21010)	ME997423 ME997439 IST=HALF KEYSTONE
				2	110 × 2.5 × 4.2	RN				
				0	110 × 5 × 3.8	RN				
6D14(New)	6557	●Truck FK615	6	1	110 × 3 × 4.3	RN		FX	20027 (21940)	ME033904 IST=HALF KEYSTONE
				2	110 × 2.5 × 4.4	RN				
				0	110 × 5 × 3.8	RN				
6D14	6557	●Truck FK615	6	1	110 × 3 × 4.3	RN		FM	20028 (21941)	ME999952
				2	110 × 2.5 × 4.4	RN				
				0	110 × 4 × 3	RN				
6D14T	6557	●Bus MK115, 115H, MM115, 515	6	1	110 × 2.8 × 4.3	RN		FM	20933 (21933)	ME997465 IST=KEYSTONE
				2	110 × 2.5 × 4.4	RN				
				0	110 × 4 × 3	RN				
6D15	6919	●Truck FK116, 216, FM316, M116, 516	6	1	113 × 3 × 4.3	RN		FX	20911 (21930)	ME072306 ME032403 IST=HALF KEYSTONE
				2	113 × 2.5 × 4.4					
				0	113 × 5 × 3.8					
エンジン型式	排気量	車名・型式	シリン ダー数	位置	サイズ 径×中×厚さ	材質	表面改質	セットタイプ	セットNo.	備考
ピストンリング										

Engine Type	cc	Vehicle Model Chassis Type	Cyl. No.	Piston Ring						Remarks
				Position	Size (mm) d ₁ ×h ₁ ×a ₁ (D×B×T)	Material	Surface Treatment	Set Type	Set No. ※	

統 MITSUBISHI MOTORS CORP. 三菱自動車工業(株)

○—ディーゼル車 Diesel-engine Automobiles

※(): OLD SET No.

6D15T	6919	●Truck FK116, 216, FM316, M116, 516	6	1	113 × 2.806 × 4.3	RN		FM	20901 (20902)	ME999954 ME999929 ME997466 ME997456 1ST=KEYSTONE				
				2	113 × 2.5 × 4.4									
				0	113 × 4 × 3									
8DV			8	1	115 × 3 × 4.3	RN		FX	20880	85017-0300				
				2	115 × 3 × 4.3									
				3	115 × 3 × 4.3									
				0	115 × 5 × 3.4									
6D16	7545	●Fighter Truck FK617A, FK618	6	1	118 × 3 × 4.6	RN		FX	20281 (21281)	ME999955 ME999540				
				2	118 × 2.5 × 4.6									
				0	118 × 4 × 3									
			●Truck FK617A	6	1	118 × 2.806 × 4.6	RN		FX	20765 (21765)	ME047030 1ST=KEYSTONE			
					2	118 × 2.5 × 4.6								
					0	118 × 4 × 3								
6D16T	7545	●Truck Fighter FK617A, FK618	6	1	118 × 2.806 × 4.6	RN		FM	20213	ME997467 1ST=KEYSTONE				
				2	118 × 2.5 × 4.6									
				0	118 × 4 × 3									
				6	1	118 × 2.8 × 3.9			SM	20143	ME996591 ME997999 1ST=KEYSTONE			
					2	118 × 2.5 × 4.6								
					0	118 × 4 × 2.95								
4M51-2	5249	●Canter	4	1	118 × 3.0 × 3.8		GN	SM	20087	ME995113 ME995114 ME995115				
				2	118 × 2.0 × 4.1									
				0	118 × 3.0 × 2.0									
6M61	8201	●Fighter	6	1	118 × 3.0 × 3.8		GN	SM	20088	ME995562				
				2	118 × 2.0 × 4.1									
				0	118 × 4.0 × 2.5									
6M61CNG	8201	●Fighter	6	1	118 × 2.5 × 3.8	RN	GN	SM	20089	ME993687 ME993688				
				2	118 × 2.0 × 4.3									
				0	118 × 4.0 × 2.5									
S4BB2			4	1	122 × 4 × 4.7	RN	Cr2	FM	20221	36317-01040 1ST=HALF KEYSTONE				
				2	122 × 3 × 5									
				0	122 × 5 × 3									
6D20, 21	10308	●Truck NP117JD, FP117FD, FD217R, K202, FP117, K202 ●Bus MP117H, MP517, MP117, 517	6	1	125 × 4 × 5	RN		FX	20029 (21350)	30917-01012 1ST=HALF KEYSTONE				
				2	125 × 3 × 5.3									
				0	125 × 6 × 4									
				1	125 × 3.306 × 5.4						RN	FX	20033 (21960)	ME052145 1ST=KEYSTONE
				2	125 × 3 × 5.3									
				0	125 × 6 × 4									
6D21	10308	●Truck MP107	6	1	125 × 3 × 5.2	RN		FX	20034 (21780)	ME052260				
				2	125 × 3 × 5.3									
				0	125 × 6 × 4									
6D22	11149	●Truck FP308, MP118, MP518	6	1	130 × 3.306 × 5.4	RN		FX	20035 (21760)	30917-20010 ME052124 ME052787 1ST=KEYSTONE				
				2	130 × 3 × 5.4									
				0	130 × 6 × 4									
エンジン型式	排気量	車名・型式	シリン ダー数	位置	サイズ 径×中×厚さ	材質	表面改質	セットタイプ	セットNo.	備考				
ピストンリング														

Engine Type	cc	Vehicle Model Chassis Type	Cyl. No.	Piston Ring						Remarks
				Position	Size (mm) d ₁ ×h ₁ ×a ₁ (D×B×T)	Material	Surface Treatment	Set Type	Set No. ※	

統 MITSUBISHI MOTORS CORP. 三菱自動車工業(株)

○—ディーゼル車 Diesel-engine Automobiles

※(): OLD SET No.

6D22	11149	●Truck FP308, MP118, MP518	6	1	130 × 3.306 × 5.4	RN	Cr4	FX	20081	ME052889
				2	130 × 3 × 5.3	RN				ME995467
				0	130 × 4 × 2.8	RN				IST=KEYSTONE
6D22	11149	●Truck FP308, MP118, MP518	6	1	130 × 3.306 × 5.4	RN	Cr4	FM	20763	ME052893
				2	130 × 3 × 5.3	RN				IST=KEYSTONE
				0	130 × 4 × 2.5					
6D22	11149	●THE GREAT	6	1	130 × 3 × 5.2		Cr1	FM	20030	ME052966
				2	130 × 3 × 5.2					(ME999136/cyl.)
				0	130 × 4 × 2.5					
8DC4G	11149	●Truck T931, T881, T910, FT102, FV112, ●Bus B801, B901	8	1	130 × 3.306 × 5.4	RN		FX	20036 (21250)	ME062298
				2	130 × 3 × 5.3					IST=KEYSTONE
				0	130 × 6 × 4					
6DC2	9955	●Truck T800GD, 810JT, T920J, FP101FD, W81, 81D, FP210R, FP101DR ●Bus B820J, B800J, 800K, 800L, B800N, 905N, 805NA, B805L	6	1	130 × 4 × 5	RN		FX	20140 (21140)	31117-02010
				2	130 × 3 × 5.3					ME062117
				0	130 × 6 × 4					31117-70010
8DC2, 4, 7	13273	●Truck T811P, 901FD, 936D, 956JD, FT102HD, F102JD, FV102JD, T811BR, 811ZR, FP112M, T902FD, FT102N, 202S, FU112N, 212R, FV112JD, FP102DR, FV102HR, FV112HR, W112, 150, 250, 400, NV112KD, HV119KD, FT102, 212S, 911N, FU102N, 119N, FV119JD, FP102DR, 112DR, T901CR, FV113HR, NV113JR, NW112KR, K252, FQ112H, FS119S, FT112, FU112, 212, FV119, FU119, FU123, FV119, FT119, 112, FQ112, FV112, NV112, FV313 ●Bus B806K, L, N, B905N, NA, B805N, NA, MS512N, 512NA, MS512	8	1	130 × 4 × 5	RN		FX	20037 (21130)	ME062117
				2	130 × 3 × 5.3					31217-02010
				0	130 × 6 × 4					ME062109
6D22	11149	●Truck FP313, MP118, 518	6	1	130 × 3 × 5.2	RN	Cr4	FX	20752 (21752)	ME052758
				2	130 × 3 × 5.4					
				0	130 × 6 × 4					
6D24	11945	●Aero Star ●The Great	6	1	130 × 3.3 × 4.5		Cr1	SM	20064	ME151190
				2	130 × 3.0 × 5.3	RN				IST=KEYSTONE
				0	130 × 4.0 × 2.45					
S6B	12880		6	1	132.9 × 4.07 × 4.9	RN	Cr4	FX	20101 (21101)	36217-14010
				2	132.9 × 3 × 5.4					IST=HALF KEYSTONE
				0	132.9 × 6 × 4	RN				
エンジン型式	排気量	車名・型式	シリン ダー数	位置	サイズ 径×巾×厚さ	材質	表面改質	セットタイプ	セットNo.	備考
ピストンリング										

Engine Type	cc	Vehicle Model Chassis Type	Cyl. No.	Piston Ring						Remarks
				Position	Size (mm) d ₁ ×h ₁ ×a ₁ (D×B×T)	Material	Surface Treatment	Set Type	Set No. ※	

統 MITSUBISHI MOTORS CORP. 三菱自動車工業(株)

○—ディーゼル車 Diesel-engine Automobiles

※(): OLD SET No.

6D40	12023	●The Great	6	1	135 × 3.306 × 5.4	RN	Cr1	FM	20086	ME121332					
				2	135 × 3.0 × 5.4	RN	Cr1			IST=KEYSTONE					
				0	135 × 4.0 × 2.95		Cr1								
8DC6, 8	14886	●Truck T902FD, 906FD, 916FD, FT103HD, FT113HD, FU103JD, FV103JD, 113JD, T812ZR, T816ZR, T902CR, 930CR, 932DR, FT102N, 203S, FT113N, 213S, FU103N, 203R, 113N, 213R, FV113JD, FP103FR, T902CR, FV113, FV103HR, 113JR, NW113KR, FW123M, FT113RP, K400, FV113, FW123, FP113, FT113, FV313,FR113	8	1	135 × 4 × 5	RN		FX	20991	IST=RECTANGULAR					
				2	135 × 3 × 5.7										
				0	135 × 6 × 4										
			●Bus B907N, NZ, SA, S, MS513, 613	8	1	135 × 4.07 × 5	RN		FX	20970 (21970)	ME062086				
											2	135 × 3 × 5.5	RN		31217-60012
											0	135 × 6 × 4	RN		
													IST=HALF KEYSTONE		
		10DC6, 8	18608	●Truck T813AR, FP204DR, NW304JR, FT204R, FT214R, FV214JR, NW204JR, FV214, FP214DR, FP214 ●Bus MS504R, MS504	10	1	135 × 4.07 × 5	RN		FX	20038 (21980)	ME062113			
						2	135 × 3 × 5.5					31917-60012			
						0	135 × 6 × 4	RN				IST=HALF KEYSTONE			
12DC		●Bus B906R	12	1	135 × 4.07 × 5	RN		FX	20039 (21680)	ME062125					
				2	135 × 3 × 5.5					IST=HALF KEYSTONE					
				0	135 × 6 × 4	RN									
8DC81	14886	FT, FJ, FV	8	1	135 × 3.306 × 5.4	RN		FX	20042 (21790) (21871)	ME062246 ME065684					
				2	135 × 3 × 5.5					ME062022					
				0	135 × 6 × 4	RN				IST=KEYSTONE					
8DC8A	14886	●Truck F413(T, U, V, P)	8	1	135 × 3.306 × 5.4	RN		FM	20791 (21791)	ME090574					
				2	135 × 3 × 5.5					IST=KEYSTONE					
				0	135 × 4 × 3										
8DC-9	16031		8	1	135 × 3.306 × 5.4	RN		FX	20046 (21661)	ME065680					
				2	135 × 3 × 5.5					ME092392					
				3	135 × 3 × 5.5					ME997826					
				0	135 × 6 × 4					IST=KEYSTONE					
	8			8	1	135 × 3.306 × 5.1	RN		SM	20577	ME996194				
					2	135 × 3 × 5.4									
					3	135 × 3 × 5.5									
					0	135 × 4 × 3					IST=KEYSTONE				
ピストンリング															
エンジン型式	排気量	車名・型式	シリンダー数	位置	サイズ 径×中×厚さ	材質	表面改質	セットタイプ	セットNo.	備考					

MITSUBISHI MOTORS CORP.
三菱自動車工業株

Engine Type	cc	Vehicle Model Chassis Type	Cyl. No.	Piston Ring					Remarks
				Position	Size (mm) d ₁ ×h ₁ ×a ₁ (D×B×T)	Material	Surface Treatment	Set Type	

統 MITSUBISHI MOTORS CORP. 三菱自動車工業(株)

○—ディーゼル車 Diesel-engine Automobiles

※(): OLD SET No.

8DC9(9T)	16031	●Tractor FP215, FV215	8	1	135 × 3.306 × 5.4	RN		FX	20043 (21770)	ME062230
				2	135 × 3 × 5.5					ME062018
				3	135 × 3 × 5.5					
				0	135 × 6 × 4	RN			IST=KEYSTONE	
8DC9(9T)	16031	●Truck FT315, FV315, FU315, FS313, FP315, FW125 ●Bus MS615	8	1	135 × 4.07 × 5	RN		FX	20420	ME062090
				2	135 × 3 × 5.5					
				3	135 × 3 × 5.5					
				0	135 × 6 × 4	RN			IST=KEYSTONE	
8DC9T	16031	●Truck FT315, FV315, FU315, FS313, FP315, FW125 ●Bus MS615	8	1	135 × 3.306 × 5.4	RN		FM	20044 (21651)	ME090578
				2	135 × 3 × 5.5					
				3	135 × 3 × 5.5					
				0	135 × 4 × 3				IST=KEYSTONE	
S6B	12880		6	1	135 × 4.07 × 5	RN		FX	20900 (21900)	36217-17010
				2	135 × 3 × 5.5					36217-11010/cyl.
				0	135 × 6 × 4	RN			IST=HALF KEYSTONE	
S6B3	14600		6	1	135 × 4 × 5	RN		FM	20181	34A17-01010/cyl.
				2	135 × 3 × 5.5					
				0	135 × 4 × 3				IST=KEYSTONE	
6DH135 12DH			6	1	135 × 4 × 5.3	RN		FX	20045 (21510) (20090)	32317-03002
				2	135 × 2.5 × 5.5					32017-03001
				0	135 × 6 × 4	RN				
8DC10	16752	F416(S, T, U, V, P)	8	1	138 × 3.306 × 5.5	RN		FX	20571	ME065717
				2	138 × 3 × 5.6					ME999510
				3	138 × 3 × 5.6					
				0	138 × 6 × 4				IST=KEYSTONE	
8DC10	17737	F419(P, U, V)	8	1	138 × 3.306 × 5.5	RN		FM	20311	ME090582
				2	138 × 3 × 5.6					ME997030
				3	138 × 3 × 5.6					
				0	138 × 4 × 3				IST=KEYSTONE	
				1	140 × 4 × 5.4	RN		FX	20830	42007-09001/cyl.
				2	140 × 4 × 5.4					
				0	140 × 6 × 5.4					
				0	140 × 6 × 5.4					
8DC11	16752	KS, FUSO KC-FV	8	1	142 × 3.306 × 5.6	RN		FX	20011 (21011)	ME065607
				2	142 × 3 × 5.8					
				3	142 × 3 × 5.8					
				0	142 × 5 × 4	RN			IST=KEYSTONE	
				1	142 × 3.306 × 5.6	RN		FM	20047 (21171)	ME090586
2	142 × 3 × 5.8				ME999990					
3	142 × 3 × 5.8									
0	142 × 4 × 3				IST=KEYSTONE					
S6AF S8AF S12AF				1	142.9 × 4.43 × 5.9	RN	Cr4	FE	20041 (21041)	32717-07010/cyl.
				2	142.9 × 2.95 × 5.7					(6cyl. 8cyl. 12cyl.)
				0	142.9 × 6 × 4	RN			IST=HALF KEYSTONE	
エンジン型式	排気量	車名・型式	シリン ダー数	位置	サイズ 径×中×厚さ	材質	表面改質	セットタイプ	セットNo.	備考
ピストンリング										

Engine Type	cc	Vehicle Model Chassis Type	Cyl. No.	Piston Ring						Remarks
				Position	Size (mm) d ₁ ×h ₁ ×a ₁ (D×B×T)	Material	Surface Treatment	Set Type	Set No. ※	

統 MITSUBISHI MOTORS CORP. 三菱自動車工業(株)

○—ディーゼル車 Diesel-engine Automobiles

※(): OLD SET No.

S6A			6	1	145 × 4.5 × 5.8	RN	Cr4	FX	20048 (21181)	32517-11010
				2	145 × 3 × 5.8					
				0	145 × 6 × 4.3					
S8A S12A	21140 33930			1	145 × 4.45 × 6	RN	Cr4	FE	20052 (21071)	32517-33010/cyl. 32517-34010/cyl. (8cyl. 12cyl.) 1ST=HALF KEYSTONE
				2	145 × 2.95 × 5.8					
				0	145 × 6 × 4.1					
8M20			8	1	146 × 3.306 × 5.3	RN		SM	20855	ME996163
				2	146 × 3 × 5.8					
				3	146 × 3 × 6					
				0	146 × 4 × 3					
8M21			8	1	150 × 3.306 × 5.3	RN		SM	20805	ME996167
				2	150 × 3 × 5.9					
				3	150 × 3 × 6.1					
				0	150 × 4 × 3					
S6DE			6	1	150 × 4.5 × 6	RN		FX	20131 (21131)	33417-00010
				2	150 × 3 × 6					
				0	150 × 6 × 4.5					
S6A S12A	18560 33930			1	150 × 4.43 × 6.2	RN	Cr4	FE	20051 (21051)	32517-07010/cyl. (6cyl. 12cyl.) 1ST=HALF KEYSTONE
				2	150 × 2.95 × 6					
				0	150 × 6 × 4.2					
S6A			6	1	150 × 4.43 × 6.2	RN	Cr4	FX	20993	32517-17100/cyl. 1ST,2ND= HALF KEYSTONE
				2	150 × 2.95 × 6					
				0	150 × 6 × 3.3					
エンジン型式	排気量	車名・型式	シリン ダー数	位置	サイズ 径×巾×厚さ	材質	表面改質	セットタイプ	セットNo.	備考
ピストンリング										

Engine Type	cc	Vehicle Model Chassis Type	Cyl. No.	Piston Ring						Remarks
				Position	Size (mm) d ₁ ×h ₁ ×a ₁ (D×B×T)	Material	Surface Treatment	Set Type	Set No.※	

●NISSAN MOTOR CO., LTD. 日産自動車(株)

○——ガソリン車 Gasoline-engine Automobiles

※(): OLD SET No.

MA10 MA10ET	987	●March	4	1	68 × 1.5 × 2.5			SV	23030 (25030)	12033-01B05
				2	68 × 1.5 × 3.1					12033-01B10
				0	68 × 2.8 × 3					12033-01B11
CG10, CG13	1000 1300	●March E-HK11, K11	4	1	71 × 1.5 × 2.6		GN	SV	23302	12033-72Y00
				2	71 × 1.5 × 3.1					
				0	71 × 2.8 × 2.8		GN			
GA13DS	1300		4	1	71 × 1.5 × 3.1	RN		FV	23285 (23282)	12033-50Y00
				2	71 × 1.5 × 3.1					
				0	71 × 2.8 × 2.8					
A10, A12, A13, F1, JC J13	1171	●Bluebird P411 ●Truck 520, 521, V521, U521, 620, G620, A321, VA321, SA321, UA321, KA321, KPA321 ●Bus GKA321 ●Sunny 1200 B10, KB10, KC20, VB10, B20 ●Sunny Truck VB10, B120 ●Cherry PE10, KPE10, F10, KF10, VP10, VF10, B-F11, A-KPC20D, H-VF10, H-PC20S, VPC20S ●Bluebird 1200 P410, WP410 ●Truck 320, V320, U320, N320, ●Truck AD320, A320, SA320, UA320, KA320, VA320	4	1	73 × 1.984 × 3	RN		FV	23431	12033-H6200
				2	73 × 1.984 × 3					12033-B3040
				0	73 × 3.967 × 3					12033-A6200
										12033-H6201
J120	1973	●Cedric P130, WP130, VP130	6	1	73 × 1.984 × 3	RN		FV	23641	12033-73004
				2	73 × 1.984 × 3					
				0	73 × 3.967 × 3					
E10S	1000	●Sunny P130, VP130, WP130	4	1	73 × 1.5 × 3	RN		FV	23053 (25051)	12033-41M02
				2	73 × 1.5 × 3					12033-41M01
				0	73 × 4 × 3.1					
GA14S	1400	●AD Ban R-VY10, VFY10	4	1	73.6 × 1.5 × 2.8		GN	SV	23292	12033-87A00
				2	73.6 × 1.5 × 3.2					12033-87A10
				0	73.6 × 2.8 × 2.8		GN			
GA15DS	1500	●AD Ban R-VY10, VFY10	4	1	73.6 × 1.5 × 2.8	RN		FV	23999	12033-53Y00
				2	73.6 × 1.5 × 3.2					
				0	73.6 × 2.8 × 2.8					
QG15DE			4	1	73.6 × 1.2 × 2.6			SV	23295	12033-5M370
				2	73.6 × 1.2 × 3.2					
				0	73.6 × 2.5 × 2.65					
エンジン型式	排気量	車名・型式	シリン ダー数	位置	サイズ 径×中×厚さ	材質	表面改質	セットタイプ	セットNo.	備考
ピストンリング										

Engine Type	cc	Vehicle Model Chassis Type	Cyl. No.	Piston Ring						Remarks
				Position	Size (mm) d ₁ ×h ₁ ×a ₁ (D×B×T)	Material	Surface Treatment	Set Type	Set No. ※	

統NISSAN MOTOR CO., LTD. 日産自動車(株)

○——ガソリン車 Gasoline-engine Automobiles

※(): OLD SET No.

G1	1484	●Skyline A41, 50, 51 ●Truck 430, 442, 640	4	1	75 × 2.4 × 3.75			FO	23070 (25410)	97011-0116P
				2	75 × 2.4 × 3.75					
				0	75 × 4 × 3.5					
G7	1988	●Skyline 54 ●Truck 41, 43, PA30, VPA30	6	1	75 × 2.4 × 3.75			FO	23090 (25470)	97011-0701P
				2	75 × 2.4 × 3.75					
				0	75 × 4 × 3.5					
A12A	1171	●Sunny YN-KNN10 ●Pulsar	4	1	75 × 2 × 3.2	RN		FV	23390	12033-H8500
				2	75 × 2 × 3.2					
				0	75 × 4 × 3.1					
A14	1397	●Sunny B-KA10, H-VA10, B-A10, B-KHB211, B-HB211, B-KPF11 ●Violet H-VHB210, HN10, VHB310, 311, A-11, VHN10, 11, HB-310, VYT-10, PC, PCG121, WHB310	4	1	76 × 2 × 3.2	RN		FV	23221	12033-H8900 12033-H7200 12033-H9910 12033-H8660
				2	76 × 2 × 3.4					
				0	76 × 4 × 3.4					
A14, A15	1397	●Sunny ●Pulsar	4	1	76 × 1.2 × 3.1			SV	23971	12033-H9800 12033-H9810 12033-H7680 12033-H9915 12033-H9918
				2	76 × 2 × 3.4					
				0	76 × 4 × 3.4					
A15	1397	●Sunny ●Pulsar	4	1	76 × 1.2 × 3.1			SV	23130 (25790)	12033-H9820
				2	76 × 2 × 3.4					
				0	76 × 4 × 3.2					
E13, E13S E15, E15S	1270 1487	●Pulsar ●Sunny ●Pulsar AD Van ●Sunny AD Van ●Datsun ADVan ●Sunny Ccalifornia ●Laurel Spirit ●AD Van	4	1	76 × 1.5 × 3.2	RN		FV	23140 (25451)	12033-01M02 12033-01M01 12033-01M12 12033-01M10
				2	76 × 1.5 × 3.4					
				0	76 × 4 × 3.4					
E13 E15	1300 1500	●Sunny ●Pulsar	4	1	76 × 1.5 × 2.8			SV	23021	12033-01M03
				2	76 × 1.5 × 3.4					
				0	76 × 4 × 3.2					
			4	1	76 × 1.5 × 2.8		Cr4	SV	23081	12033-01M04 12033-17M00 12033-17M10
				2	76 × 1.5 × 3.4					
				0	76 × 4 × 3.25					
E15T			4	1	76 × 1.5 × 2.8			SV	23993	12033-61A01
				2	76 × 1.5 × 3.4					
				0	76 × 4 × 3.1					
MC3			4	1	76 × 1.5 × 3.1			SV	23304	12033-0M600
				0	76 × 2.8 × 2.5					

エンジン型式	排気量	車名・型式	シリン ダー数	位置	サイズ 径×巾×厚さ	材質	表面改質	セットタイプ	セットNo.	備考
--------	-----	-------	------------	----	------------	----	------	--------	--------	----

ピストンリング

Engine Type	cc	Vehicle Model Chassis Type	Cyl. No.	Piston Ring						Remarks
				Position	Size (mm) d ₁ ×h ₁ ×a ₁ (D×B×T)	Material	Surface Treatment	Set Type	Set No. ※	

統NISSAN MOTOR CO., LTD. 日産自動車(株)

○——ガソリン車 Gasoline-engine Automobiles

※(): OLD SET No.

GA16S	1600	●Sunny Pulsar VW10, VAJC23, EB13, KAJC23	4	1	76 × 1.5 × 3.2	RN		FV	23315	12033-57Y00
				2	76 × 1.5 × 3.2					12033-57Y01
				0	76 × 2.8 × 2.8					12033-84A11
GA16	1600	●Sunny Pulsar VW10, VAJC23, EB13, KAJC23	4	1	76 × 1.5 × 2.8		GN	SV	23998 (25998)	12033-94M00
				2	76 × 1.5 × 3.4					12033-94M01
				0	76 × 2.8 × 2.8		GN			12033-94M02
VD20DE			6	1	76 × 1.2 × 2.8			SV	23128	12033-31U00
				2	76 × 1.2 × 3.2					
				0	76 × 2.5 × 3.1					
VQ20			6	1	76 × 1.2 × 2.8			SV	23002	12033-3Y501
				2	76 × 1.2 × 3.2					12033-31U10
				0	76 × 2.5 × 3.1					12033-2Y015
QG16DE	1600		4	1	76 × 1.2 × 2.8			SV	23080	12033-7J910
				2	76 × 1.2 × 3.2					
				0	76 × 2.5 × 2.65					
J15, J16	1567	●Caravan ●Datsun ●Truck N521, G521, UN521, VN521 ●Bus SVE20, H-VSE20, VPE20 ●Truck T20, VV20, HT20, VHT20 ●Bus VE20, HE20, KT20, GKE20	4	1	77.95 × 2 × 3.5	RN		FV	23210	12033-01W60
				2	77.95 × 2 × 3.7					12033-B3030
				0	77.95 × 4 × 3.4					12033-01W61
										12033-01W62
									12033-B8200	
L20ET	1998	●Skyline	6	1	77.95 × 2 × 3.7	RN		FV	23091 (23981)	12033-V0310
				2	77.95 × 2 × 3.7					12033-V0300
				0	77.95 × 4 × 3.4					12033-E3030
									12033-V0400	
L20A	1998		6	1	77.95 × 2 × 3.6	RN		FV	23500	12033-73402
				2	77.95 × 2.5 × 3.7					
				0	77.95 × 4 × 3.4					
エンジン型式	排気量	車名・型式	シリン ダ―数	位置	サイズ 径×中×厚さ	材質	表面改質	セットタイプ	セットNo.	備考
ピストンリング										

Engine Type	cc	Vehicle Model Chassis Type	Cyl. No.	Piston Ring					Remarks
				Position	Size (mm) d ₁ ×h ₁ ×a ₁ (D×B×T)	Material	Surface Treatment	Set Type	

統NISSAN MOTOR CO., LTD. 日産自動車(株)

○——ガソリン車 Gasoline-engine Automobiles

※(): OLD SET No.

L20A	1998	●Cedric H130, WH130, VH130, K230, W230, V230, K330, L330, HV330 ●BlueBird C-RG810, KG610, G610 ●Gloria HA30, VHA30 ●Skyline2000GT GC10, GC110, AGC110, KGC110, KPC110, WPC110, KGC10 ●Fairlady-Z S30, PS30, SG30, A-S30, AG610, KG610, CRG810	6	1	77.95 × 1.5 × 3.3	RN		FV	23921	12033-01L00
				2	77.95 × 2 × 3.6					
				0	77.95 × 4 × 3.4					
L20A(New)	1998	●Skyline ●Fairlady	6	1	77.95 × 1.2 × 3.3			SV	23841	12033-Y7000
				2	77.95 × 2 × 3.7				(25541)	12033-Y7010
				0	77.95 × 4 × 3.4					12033-Y7011
CA16	1598	●Stanza ●Auster	4	1	77.95 × 1.5 × 3.3	RN		FV	23180 (25291)	12033-D0400
				2	77.95 × 1.5 × 3.5					12033-D0120
				0	77.95 × 4 × 3.4					12033-06E10 12033-06E00
			4	1	77.95 × 1.5 × 2.8			SV	23220 (25181)	12033-55M00
				2	77.95 × 1.5 × 3.4					
				0	77.95 × 2.8 × 2.7					
CA16DE			4	1	77.95 × 1.5 × 2.8		GN	SV	23101	12033-64M00
				2	77.95 × 1.5 × 3.4					
				0	77.95 × 2.8 × 2.7					
VG20	1998	●Cedric ●Fairlady-Z	6	1	77.95 × 1.5 × 2.8			SV	23980 (25980)	12033-V5310
				2	77.95 × 1.5 × 3.4					
				0	77.95 × 2.8 × 2.7					
RB20E	1998		6	1	77.95 × 1.5 × 2.85		Cr4	SV	23230 (25991)	12033-65L00
				2	77.95 × 1.5 × 3.4					
				0	77.95 × 2.8 × 2.75					
XH1E			4	1	78 × 1.2 × 2.45			SV	23120	12033-EE000
				2	78 × 1.2 × 2.7					
				0	78 × 2 × 2.2					
XH2E			4	1	78 × 1.2 × 2.45			SV	23320	12033-ED000
				2	78 × 1.2 × 2.7					
				0	78 × 2 × 2.2					
HR15DE HR16DE	1498 1598	●TIIDA ●NOTE	4	1	78 × 1.2 × 2.5		Cr1	SV	23036	12033-1KA0A
				2	78 × 1.2 × 2.7					
				0	78 × 2 × 2.2					
QG18DE			4	1	80 × 1.2 × 2.8			SV	23340	12033-5M020 12033-5M060
				2	80 × 1.2 × 3.6					
				0	80 × 2.5 × 2.65					
エンジン型式	排気量	車名・型式	シリン ダー数	位置	サイズ 径×中×厚さ	材質	表面改質	セットタイプ	セットNo.	備考
ピストンリング										

Engine Type	cc	Vehicle Model Chassis Type	Cyl. No.	Piston Ring					Remarks
				Position	Size (mm) d ₁ ×h ₁ ×a ₁ (D×B×T)	Material	Surface Treatment	Set Type	

統NISSAN MOTOR CO., LTD. 日産自動車(株)

○——ガソリン車 Gasoline-engine Automobiles

※(): OLD SET No.

J18	1800		4	1	80.5 × 1.5 × 3.5	RN		FV	23701 (25701)	12033-N7900
				2	80.5 × 2 × 3.7					12033-24W00
				0	80.5 × 4 × 3.4					12033-J2190 12033-J21G0
G15	1483	●Skyline C10, C10M, C10WT, C10S, WC10M, VC10M, VC10S	4	1	82 × 2 × 4.1		Cr4	FV	23480 (25480)	12033-28500
				2	82 × 2 × 4.1					
				0	82 × 4 × 3.9					
S20	1989	●Fairlady PS30	6	1	82 × 2 × 4.1		Cr4	FV	23790	12033-A0201
				2	82 × 2 × 4.1					
				0	82 × 4 × 3.9					
SR18DI			4	1	82.5 × 1.5 × 3.3			SV	23251	12033-64J00
				0	82.5 × 3 × 2.5					
CA18N	1800	FC33, FJ32, KHGC22,	4	1	82.7 × 1.5 × 3.1		GN	SV	23371	12033-64E10
				2	82.7 × 1.5 × 3.7					
				0	82.7 × 2.8 × 2.8		GN			
CA18T			4	1	83 × 1.5 × 3.1			SV	23073	12033-59B00
				2	83 × 1.5 × 3.7					
				0	83 × 2.8 × 2.8					
L13 L14 L16	1300 1400 1600	●Bluebird 1300 510, V510, W510 ●Bluebird 1400 N510, VH510 ●Violet J710, JK710, VJ710 ●Sunny A-PB210, PB210	4	1	83 × 2 × 3.95	RN		FV	23031	12033-A3501
				2	83 × 2 × 3.9					12033-A3500
				0	83 × 4 × 3.4					12033-W0700
										12033-A0600 12033-21000 12033-23000
L24 L26	2400 2600	●Bluebird	6	1	83 × 2 × 3.95	RN		FV	23890	12033-E3110
				2	83 × 2 × 3.9					12033-W0810
				0	83 × 4 × 3.4					12033-E3100 12033-A8620
L24	2400	●Bluebird	6	1	83 × 1.5 × 3.1		Cr4	SV	23240 (25081)	12033-51L00
				2	83 × 1.5 × 3.6					
				0	83 × 4 × 3.45					
Z16	1595	●Violet ●Auster BC111, J811, SKS110, PA11, PA10, GRA, FPA, KL811	4	1	83 × 1.2 × 3.6			SV	23780	12033-W7002
				2	83 × 2 × 3.9					
				0	83 × 4 × 3.4					
Z16	1595	●Violet ●Auster	4	1	83 × 2 × 3.95	RN		FV	23591	12033-W7110
				2	83 × 2 × 3.9					
				0	83 × 4 × 3.4					
L24	2400	●Bluebird	6	1	83 × 1.5 × 3.6	RN		FV	23260 (25921)	12033-W3100
				2	83 × 1.5 × 3.6					
				0	83 × 4 × 3.4					
エンジン型式	排気量	車名・型式	シリン ダー数	位置	サイズ 径×巾×厚さ	材質	表面改質	セットタイプ	セットNo.	備考
ピストンリング										

Engine Type	cc	Vehicle Model Chassis Type	Cyl. No.	Piston Ring						Remarks
				Position	Size (mm) d ₁ ×h ₁ ×a ₁ (D×B×T)	Material	Surface Treatment	Set Type	Set No. ※	

統NISSAN MOTOR CO., LTD. 日産自動車(株)

○——ガソリン車 Gasoline-engine Automobiles

※(): OLD SET No.

CA18T	1809	●Stanza ●Auster	4	1	83 × 1.5 × 3			SV	23521	12033-17F00		
				2	83 × 1.5 × 3.7				(25760)	12033-18F00		
				0	83 × 2.8 × 3.2					12033-18F10		
L24	2400	●Bluebird	6	1	83 × 1.2 × 3.6			SV	23300	12033-U8770		
				2	83 × 2 × 3.9				(25561)			
				0	83 × 4 × 3.4							
L24	2400	●Bluebird	6	1	83 × 1.5 × 3.6	RN		FV	23350	12033-W2420		
				2	83 × 2 × 3.9				(25571)	12033-W2410		
				0	83 × 4 × 3.4				(23421)	12033-W2400		
		(23231)										
CA18	1809	●Stanza ●Auster	4	1	83 × 1.5 × 3.6	RN		FV	23142	12033-01F00		
				2	83 × 1.5 × 3.6				(25141)	12033-D0210		
				0	83 × 4 × 3.4				(25351)	12033-D0500		
		(25100)							12033-01E10 12033-01E00			
MR18DE MR20DE	1797 1999	●Tiida ●Lafesta ●Cube ●Versa ●Sentra	4	1	84 × 1.2 × 2.6			SV	23045	12033-EN200		
				2	84 × 1.2 × 3.0						12033-CK80A	
				0	84 × 2.0 × 2.5						12033-EN20A	
CA20	1973	●Bluebird M11, KMGC22, VNY30	4	1	84.5 × 1.5 × 3.6	RN		FV	23420	12033-D2000		
				2	84.5 × 1.5 × 3.9				(25250)	12033-D1700		
				0	84.5 × 4 × 3.4				(25840)	12033-04E10 12033-04E00		
CA20S	2000	KMGC22, M11, VNY30	4	1	84.5 × 1.5 × 3.1		GN	SV	23381	12033-61E10		
				2	84.5 × 1.5 × 3.7							
				0	84.5 × 2.8 × 2.8							
CA20S	1973	KMGC22, VNY30	4	1	84.5 × 1.5 × 3.1		GN	SV	23382	12033-35R00		
				2	84.5 × 1.5 × 3.7							
				0	84.5 × 2.8 × 2.8							
CA20	1973	●Bluebird M11, KMGC22, VNY30	4	1	84.5 × 1.5 × 3.15			Cr4	SV	23990	12033-13E00	
				2	84.5 × 1.5 × 3.7							
				0	84.5 × 2.8 × 2.8							
CA20	1973	●Bluebird M11, KMGC22, VNY30	4	1	84.5 × 1.5 × 3.15			Cr4	SV	23430 (25201)	12033-D4710	
				2	84.5 × 1.5 × 3.9							
				0	84.5 × 4 × 3.35							
Z18	1770	●Bluebird	4	1	85 × 2 × 4.05	RN		FV	23581	12033-W1600		
				2	85 × 2 × 4.05						12033-W1510	
				0	85 × 4 × 3.4						12033-N9700	
エンジン型式	排気量	車名・型式	シリン ダー数	位置	サイズ 径×中×厚さ	材質	表面改質	セットタイプ	セットNo.	備考		
ピストンリング												

Engine Type	cc	Vehicle Model Chassis Type	Cyl. No.	Piston Ring						Remarks
				Position	Size (mm) d ₁ ×h ₁ ×a ₁ (D×B×T)	Material	Surface Treatment	Set Type	Set No. ※	

統NISSAN MOTOR CO., LTD. 日産自動車(株)

○——ガソリン車 Gasoline-engine Automobiles

※(): OLD SET No.

G18 L18	1770	●Laurel c30, kc30 ●Skyline PC10, 110, WPC10, 110, PKC10, 110, VPC10, 110 ●Bluebird KH510, P610, KP610, H510, KH510, AP610, C-PJ810, C-P810	4	1	85 × 2 × 3.9		Cr4	FV	23601	12033-W0805			
				2	85 × 2 × 4.2					12033-A8701			
				0	85 × 4 × 3.4					12033-A8702			
				1	85 × 2 × 3.9					Cr1	FV	23605	
				2	85 × 2 × 4.2								
				0	85 × 4 × 3.4								
Z18	1770	●Auster ●Stanza KPC231, F30, PC231, FRA11, P, PG, WP910,S-KS110	4	1	85 × 1.2 × 3.6			SV	23770	12033-U5810			
				2	85 × 2 × 4.2								
				0	85 × 4 × 3.4								
Z20F	1952	●Bluebird ●Silvia	4	1	85 × 1.2 × 3.6			SV	23171	12033-N8500			
				2	85 × 1.5 × 3.9								
				0	85 × 4 × 3.4								
Z20	1952	●Laurel KVC231	4	1	85 × 1.5 × 3.6	RN		FV	23461 (23271)	12033-N8520			
				2	85 × 1.5 × 3.9					12033-N8510			
				0	85 × 4 × 3.4								
Z20	1952	●Laurel KHE24	4	1	85 × 1.5 × 3.15		GN	SV	23272	12033-24G00			
				2	85 × 1.5 × 3.7								
				0	85 × 4 × 3.1								
L20B	1998	●Skyline	4	1	85 × 2 × 4.05	RN		FV	23131	12033-W0815			
				2	85 × 2 × 4.2					12033-U6000			
				0	85 × 4 × 3.4					12033-U6001			
L20B	1998	●Skyline	4	1	85 × 1.2 × 3.6			SV	23911	12033-04W00			
				2	85 × 2 × 4.2								
				0	85 × 4 × 3.4								
VQ25DD	2500		6	1	85 × 1.2 × 3.05			SV	23325	12033-AL501			
				2	85 × 1.2 × 3.5								
				0	85 × 2 × 2.5						GN		
ZV2K2	2500	●Skyline	6	1	85 × 1.2 × 3.1			SV	23026	12033-EG201			
				2	85 × 1.2 × 3.5								
				0	85 × 2 × 2.5								
P	3956	●Truck 680, 681, 780, 780, 780, T780, S780 ●Bus E690	6	1	85.69 × 2.5 × 3.7			FV	23621	12033-C6000			
				2	85.69 × 2.5 × 3.7					12033-58003			
				0	85.69 × 4.73 × 4.1					12033-58004			
P40			6	1	85.69 × 2.5 × 3	RN	Cr4	FV	23460 (25990)	12033-C6011			
				2	85.69 × 2.5 × 3.5								
				0	85.69 × 4.73 × 3.4								
エンジン型式	排気量	車名・型式	シリン ダー数	位置	サイズ 径×中×厚さ	材質	表面改質	セットタイプ	セットNo.	備考			
ピストンリング													

Engine Type	cc	Vehicle Model Chassis Type	Cyl. No.	Piston Ring						Remarks
				Position	Size (mm) d ₁ ×h ₁ ×a ₁ (D×B×T)	Material	Surface Treatment	Set Type	Set No. ※	

統NISSAN MOTOR CO., LTD. 日産自動車(株)

○——ガソリン車 Gasoline-engine Automobiles

※(): OLD SET No.

RB30E	3000		6	1	86 × 1.5 × 3.1		GN	SV	23490 (25000)	12033-67S10				
				2	86 × 1.5 × 3					12033-B4910				
				0	86 × 2.8 × 3.1									
L28E	2753	●Leopard ●Fairlady	6	1	86 × 2 × 4.05	RN		FV	23281	12033-P8360				
				2	86 × 2 × 4.05					12033-P8370				
				0	86 × 4 × 3.4									
L28	2753	●Laurel 2800 A-P330, KSC130, KP330, CKNC230, A-SC130, CNC230	6	1	86 × 2 × 4.05	RN		FV	23550 (25591)	12033-N4200				
				2	86 × 2 × 3.4					12033-N4210				
				0	86 × 4 × 3.4					12033-N4220				
				1	86 × 1.2 × 3.6						SV	23481	12033-Q1110	
				2	86 × 2 × 4.2								12033-Q1100	
				0	86 × 4 × 3.4									
L28E	2753	●Laurel A-P330, KSC130, KP330, CKNC230, A-SC130, CNC230	6	1	86 × 1.5 × 3.6	RN		FV	23560 (25581)	12033-P7910				
				2	86 × 2 × 4.05					12033-P7900				
				0	86 × 4 × 3.4									
				1	86 × 1.5 × 3.6					RN	Cr4	FV	23580 (25100)	12033-P8600
				2	86 × 2 × 4.05									12033-P8610
				0	86 × 4 × 3.4									
SR20DE	1998	●Bluebird HP10, PS13, KBC23, NU13, RNN14	4	1	86 × 1.5 × 3.1			SV	23695	12033-53T00				
				2	86 × 1.5 × 3.7					12033-60J22				
				0	86 × 3 × 3.1					12033-60J62 12033-60J20 12033-53J00				
SR20			4	1	86 × 1.2 × 3.1			SV	23001	12033-2J210				
				2	86 × 1.2 × 3.7									
				0	86 × 2.5 × 2.65									
SR20	2000	●Bluebird ●Silvia 180SX	4	1	86 × 1.2 × 3.1		GN	SV	23410	12033-4M802				
				2	86 × 1.2 × 3.7									
				0	86 × 2.5 × 2.65									
SR20D	2000	●Silvia	4	1	86 × 1.2 × 3.1		GN	SV	23024	12033-3J610				
				2	86 × 1.2 × 3.7									
				0	86 × 2.5 × 2.8					GN				
NA20S			4	1	86 × 1.5 × 3.1			SV	23501	12033-85G00				
				2	86 × 1.5 × 3.7									
				0	86 × 4 × 3.4									
VG30	2960	●Cedric ●Fairlady ●Gloria	6	1	87 × 1.5 × 3.1			SV	23950 (25950)	12033-03P00				
				2	87 × 1.5 × 3.9					12033-02P10				
				0	87 × 2.8 × 3.1					12033-03P10 12033-21P10				
VG30	2960	●Caraban BP430, KEE24, WHYD21, JPY32, Z32, PY32, CZ32	6	1	87 × 2 × 3.1	RN		FV	23435 (25435)	12033-15G10				
				2	87 × 1.5 × 3.8					12033-V8000				
				0	87 × 2.8 × 2.47					12033-15V00				
エンジン型式	排気量	車名・型式	シリンダー数	位置	サイズ 径×中×厚さ	材質	表面改質	セットタイプ	セットNo.	備考				
ピストンリング														

NISSAN MOTOR CO., LTD.
日産自動車(株)

Engine Type	cc	Vehicle Model Chassis Type	Cyl. No.	Piston Ring						Remarks
				Position	Size (mm) d ₁ ×h ₁ ×a ₁ (D×B×T)	Material	Surface Treatment	Set Type	Set No. ※	

統NISSAN MOTOR CO., LTD. 日産自動車(株)

○——ガソリン車 Gasoline-engine Automobiles

※(): OLD SET No.

VG30	2960	●Caraban PY31, KE24, WHYD21, JPY32, Z32, PY32, CZ32	6	1	87 × 1.5 × 3.1		GN	SV	23590 (25952)	12033-17V00								
				2	87 × 1.5 × 3.9					12033-17V01								
				0	87 × 2.8 × 3.1													
Z22	2187	●Datsun Truck ●Cabstar UW40	4	1	87 × 1.5 × 3.6	RN		FV	23301 (23491)	12033-06W20								
				2	87 × 1.5 × 3.6					12033-06W10								
				0	87 × 4 × 3.4					12033-D8500								
			4	1	87 × 1.5 × 3.1			SV	23492	12033-T8300								
				2	87 × 1.5 × 3.9					12033-T8301								
				0	87 × 4 × 3.1													
H20 H20P	1982	●Cedric 130, V130, N230, VN230, AN230 ●Bus GC240, GC142, CH240, GHC240, GHC1412, CHWT40, GHT40, A-KPSE20, H-GKPE20, GHWT40, GHT40, A-KPSE20, H-GKPE20, GHWT40, 657, 664, KC142, KC240 ●Truck HC240, 655, 657, 662, C142, C240, DC240, VC655, D660, 641, V641, 641A, 642, 41, 140 ●Silvia CPS311 ●Fairlady SP311 ●Bluebird R411 ●Truck 446, 446a, 641A, V641 ●President 150, 250 ●Truck C80, SC80, DSC80 ●Cedric Y130	4	1	87.2 × 2 × 4	RN		FV	23141	12033-Y4460								
				2	87.2 × 2.5 × 4					12033-14601								
				0	87.2 × 4 × 3.9					12033-R9000								
															12033-R9023			
				FJ20	1990					●Skyline	4	1	89 × 1.5 × 3.7	RN		FV	23600 (25711)	12033-R2000
												2	89 × 1.5 × 3.9					
												0	89 × 2.8 × 3.4					
				G20	1990					●Laurel PC30, 130, KPC30, 130	4	1	89 × 2 × 4.3		Cr4	FV	23800	12033-E6800
												2	89 × 2 × 4.3					
												0	89 × 4 × 3.9					
				NA20P							4	1	89 × 1.5 × 3.1		GN	SV	23153	12033-86G00
												2	89 × 1.5 × 3.9					
0	89 × 2.8 × 2.8																	
エンジン型式	排気量	車名・型式	シリン ダ―数	位置	サイズ 径×巾×厚さ	材質	表面改質	セットタイプ	セットNo.	備考								
ピストンリング																		

Engine Type	cc	Vehicle Model Chassis Type	Cyl. No.	Piston Ring						Remarks
				Position	Size (mm) d ₁ ×h ₁ ×a ₁ (D×B×T)	Material	Surface Treatment	Set Type	Set No. ※	

統NISSAN MOTOR CO., LTD. 日産自動車(株)

○——ガソリン車 Gasoline-engine Automobiles

※(): OLD SET No.

Z24	2400	●Datsun Truck	4	1	89 × 2 × 3.1		GN	SV	23422	12033-13G10								
				2	89 × 1.5 × 3.9				(25422)	12033-83W00								
				0	89 × 4 × 3.4													
							4	1	89 × 2 × 3.1		Cr1	SV	23442					
								2	89 × 1.5 × 3.9				(25442)					
								0	89 × 4 × 3.4									
											4	1	89 × 1.5 × 3.7	RN		FV	23270	12033-30W10
												2	89 × 1.5 × 3.9				(25270)	12033-10W00
												0	89 × 4 × 3.4					
KA24	2388	●Largo HM11, W30	4	1	89 × 1.5 × 3.1			SV	23935	12033-53F01								
			4	2	89 × 1.5 × 3.9					12033-70F00								
			4	0	89 × 2.8 × 3.1													
KA24DE			4	1	89 × 1.5 × 3.1			SV	23125	12033-1E400								
			4	2	89 × 1.5 × 3.9					12033-4E100								
			4	0	89 × 2.8 × 3.1													
KA24DE			4	1	89 × 1.2 × 3.3			SV	23165	12033-5V110								
			4	2	89 × 1.2 × 3.8				(23615)									
			4	0	89 × 2.5 × 3.1													
KA24GN	2389	●Caravan	4	1	89 × 1.2 × 3.3		GN	SV	23720	12033-VJ260								
			4	2	89 × 1.2 × 3.8					12033-VJ261								
			4	0	89 × 2.5 × 3.1		GN											
QR20DE	2000	●Teana	4	1	89 × 1.2 × 3.3		GN	SV	23018	12033-8H301								
			4	2	89 × 1.2 × 3.8					12033-9H500								
			4	0	89 × 2.5 × 3.1					12033-EA000								
			4							12033-EA00B								
QR20DE 25DE K21			4	1	89 × 1.2 × 3.3			SV	23160	12033-AE003								
			4	2	89 × 1.2 × 3.8					12033-GS00A								
			4	0	89 × 2.5 × 2.65													
QR25DE	2488	●PRESAGE ●SERENA	4	1	89 × 1.2 × 3.3		Cr1	SV	23039	12033-AE00B								
			4	2	89 × 1.2 × 3.8													
			4	0	89 × 2.5 × 2.65		Cr1											
VG33E			6	1	91.5 × 1.5 × 3.25			SV	23375	12033-0W000								
			6	2	91.5 × 1.5 × 4													
			6	0	91.5 × 2.8 × 2.8													
Y40 Y44E	4414	●President H150 ●President H250, A-H250, E-H252, H252, C-H251	8	1	92 × 2 × 4.18	RN		FV	23670	12033-F1100								
			8	2	92 × 2.5 × 4.4					12033-F1110								
			8	0	92 × 4 × 4.1													
FJ24	2400	●Rally	4	1	92 × 1.5 × 3.7	RN		FV	23610	12033-B3400								
			4	2	92 × 1.2 × 3.7	RN			(25650)									
			4	0	92 × 2.5 × 2.8													
VD30DE			6	1	93 × 1.2 × 3.3		GN	SV	23016	12033-47U01								
			6	2	93 × 1.2 × 4													
			6	0	93 × 2.5 × 2.8		GN											

エンジン型式	排気量	車名・型式	シリン ダー数	位置	サイズ 径×中×厚さ	材質	表面改質	セットタイプ	セットNo.	備考
--------	-----	-------	------------	----	------------	----	------	--------	--------	----

Engine Type	cc	Vehicle Model Chassis Type	Cyl. No.	Piston Ring					Remarks
				Position	Size (mm) d ₁ ×h ₁ ×a ₁ (D×B×T)	Material	Surface Treatment	Set Type	

統NISSAN MOTOR CO., LTD. 日産自動車(株)

○——ガソリン車 Gasoline-engine Automobiles

※(): OLD SET No.

VD35DE VQ35			6	1	95.5 × 1.2 × 3.5			SV	23830	12033-8J100 12033-2Y903
				2	95.5 × 1.2 × 4.1					
				0	95.5 × 2.5 × 2.65					
VQ35DEK3	3500	●Murano	6	1	95.5 × 1.2 × 3.1			SV	23027	12033-JP00A
				2	95.5 × 1.2 × 4.1					
				0	95.5 × 2 × 2.5					
VQ35HR	3498	●Skyline ●FUGA	6	1	95.5 × 1.2 × 3.1		Cr1	SV	23035	12033-JK20A
				2	95.5 × 1.2 × 3.8					
				0	95.5 × 2 × 2.5					
TB42 TB42E	4169	●Safa	6	1	96 × 2 × 3.3		GN	SV	23121	12033-03J00
				2	96 × 2 × 4.2					
				0	96 × 4 × 3.4					
TB480DE TB480			6	1	99.5 × 2 × 3.6		GN	SV	23665 (23667)	12033-VB000 12033-VC200
				2	99.5 × 1.5 × 4.2					
				0	99.5 × 4 × 3.4					
エンジン型式	排気量	車名・型式	シリン ダー数	位置	サイズ 径×巾×厚さ	材質	表面改質	セットタイプ	セットNo.	備考
ピストンリング										

Engine Type	cc	Vehicle Model Chassis Type	Cyl. No.	Piston Ring						Remarks
				Position	Size (mm) d ₁ ×h ₁ ×a ₁ (D×B×T)	Material	Surface Treatment	Set Type	Set No. ※	

統NISSAN MOTOR CO., LTD. 日産自動車(株)

○——ディーゼル車 Diesel-engine Automobiles

※(): OLD SET No.

CD17	1700	●Sunny N12, N13	4	1	80 × 1.75 × 3.3	RN		FX	23331 (25331)	12033-16A00
				2	80 × 2 × 3.3					
				0	80 × 3 × 2.5					
CD17	1700		4	1	80 × 1.75 × 3.1		GN	SX	23280 (25280)	12033-16A10
				2	80 × 2 × 3.3					
				0	80 × 3 × 2.5					
SD20 SD22	1991 2164	●Cedric Q130, Q230, Q330	4	1	83 × 2.5 × 3.5	RN	Cr4	FX	23050 (24050) (24740)	12033-Y1402
				2	83 × 2 × 3.4	RN				12033-V1310
				3	83 × 2 × 3.4					12033-Y1404
				0	83 × 4.5 × 3					12033-Y1410
				0	83 × 4.5 × 3					12033-Y1401
										12033-Y1400
			12033-Y1412							
									IST=HALF KEYSTONE	
SD22			4	1	83 × 2.5 × 3.5		Cr4	FX	23750	12033-76202
				2	83 × 2 × 3.4					12033-76203
				3	83 × 2 × 3.4					12033-76204
				0	83 × 4.5 × 3					
				0	83 × 4.5 × 3					
SD33	3246	●Truck QC80, QSC80, DQSC80, DQSC80A, B	6	1	83 × 2.5 × 3.5	RN	Cr4	FX	23060 (24060)	12033-J2204
				2	83 × 2 × 3.4	RN				12033-J2202
				3	83 × 2 × 3.4					12033-J2200
				0	83 × 4.5 × 3					12033-61503
				0	83 × 4.5 × 3					12033-61502
										12033-61500
									IST=HALF KEYSTONE	
SD33T	3246	●Patrol	6	1	83 × 2.5 × 3.5	RN		FX	23900	12033-90000
				2	83 × 2 × 3.4	RN				
				3	83 × 2 × 3.4					
				0	83 × 4.5 × 3					
				0	83 × 4.5 × 3.4					
										IST=KEYSTONE
SD22(New)	2164	●Truck Q22, Q40, QC141, QC240, DQC240, HQC142, QC, DQC, HQC240 ●Bus CQC240, GHQC240, 658, 665	4	1	83 × 2.5 × 3.5	RN		FX	23485 (23470)	12033-R8100
				2	83 × 2 × 3.4	RN				12033-R8104
				0	83 × 4.5 × 3					12033-R8110
										12033-R8112
									12033-R8114	
									12033-R8103	
SD33(New)	3246		6	1	83 × 2.5 × 3.5	RN	Cr4	FX	23233 (25233) (25360)	12033-C6812
				2	83 × 2 × 3.4	RN				
				3	83 × 2 × 3.4					
				0	83 × 4.5 × 3					
				0	83 × 4.5 × 3.4					
										IST=HALF KEYSTONE
SD33T	3246		6	1	83 × 2.5 × 3.5	RN		FX	23400 (24400)	12033-C8702
				2	83 × 2 × 3.4	RN				12033-C8704
				0	83 × 4 × 2.8					IST=HALF KEYSTONE
エンジン型式	排気量	車名・型式	シリン ダー数	位置	サイズ 径×巾×厚さ	材質	表面改質	セットタイプ	セットNo.	備考
ピストンリング										

Engine Type	cc	Vehicle Model Chassis Type	Cyl. No.	Piston Ring						Remarks
				Position	Size (mm) d ₁ ×h ₁ ×a ₁ (D×B×T)	Material	Surface Treatment	Set Type	Set No. ※	

統 NISSAN MOTOR CO., LTD. 日産自動車(株)

○ ————ディーゼル車 Diesel-engine Automobiles

※ (): OLD SET No.

SD15 SD16	1500	●Cedric-Diesel	3	1	83 × 2.5 × 3.5	RN		FX	23170	12033-L2212
	1600			2	83 × 2 × 3.4	RN			(25170)	12033-L2214
				0	83 × 4.5 × 3					
LD28	2792	●Datsun Truck	6	1	84.5 × 2 × 3.5	RN		FX	23261	12033-V0700
				2	84.5 × 2 × 3.5					
				0	84.5 × 4 × 2.9					
CD20	1952	●Datsun Truck VUJC22	4	1	84.5 × 2 × 3.1		GN	SM	23262	12033-57J00
				2	84.5 × 2 × 3.7		GN			
				0	84.5 × 3 × 2.8		GN			
CD20	2000		4	1	84.5 × 2 × 3.1		GN	SM	23263	12033-1C300
				2	84.5 × 2 × 3.5		GN			
				0	84.5 × 3 × 2		GN			
LD20	1952	●Datsun Truck VUJC22	4	1	85 × 2 × 3.5	RN		FX	23951	12033-W1700
				2	85 × 2 × 3.5					
				0	85 × 4 × 2.5					
RQ1	3000	●Datsun Truck	6	1	85 × 2 × 3.5	RN		FX	23010	12033-V7200
				2	85 × 2 × 3.5				(25010)	12033-35E00
				0	85 × 4 × 2.5				(25012)	12033-W3400
LD20	1952	●Datsun Truck VUJC22	4	1	85 × 2 × 3.5	RN		FX	23013	12033-35E25
				2	85 × 2 × 3.5				(25013)	
				0	85 × 4 × 2.5					
LD20T	1952	●Datsun Truck VUJC22	4	1	85 × 2 × 3.5	RN	Cr2	FX	23680	12033-W4200
				2	85 × 2 × 3.5				(25151)	
				0	85 × 4 × 2.5					
RD-28T	2800	●Laurel	6	1	85 × 2 × 3.1		GN	SM	23003	12033-22J11
				2	85 × 2 × 3.5		GN			
				0	85 × 4 × 2.5		GN			
RD28TQ	2825	●GLORIA ●Laurel	4	1	85 × 2.0 × 3.1		GN	SM	23043	12033-81T10
				2	85 × 2.0 × 3.5		Cr1			
				0	85 × 4.0 × 2.5		GN			
									1ST=HALF KEYSTONE	
RD-28	2800	●Laurel	6	1	85 × 2 × 3.1		GN	SM	23004	12033-40L11
				2	85 × 2 × 3.5		GN			12033-20V01
				0	85 × 4 × 2.5		GN			
YD22	2200		4	1	86 × 1.75 × 3.1		GN	SM	23150	12033-WD000
				2	86 × 1.5 × 3.15		GN			
				0	86 × 3 × 2		GN			
YD22ET1	2184	●X-TRAIL T30	4	1	86 × 2 × 3.1		GN	SM	23029	12033-8H800
				2	86 × 2 × 3.6		Cr1			
				0	86 × 3 × 2		GN			
YD22DDT1	2184	●X-TRAIL T30	4	1	86 × 2 × 3.1		GN	SM	23042	12033-AW400
				2	86 × 2 × 3.5		GN			
				0	86 × 3 × 2		GN			
エンジン型式	排気量	車名・型式	シリン ダー数	位置	サイズ 径×中×厚さ	材質	表面改質	セットタイプ	セットNo.	備考
ピストンリング										

Engine Type	cc	Vehicle Model Chassis Type	Cyl. No.	Piston Ring						Remarks
				Position	Size (mm) d ₁ ×h ₁ ×a ₁ (D×B×T)	Material	Surface Treatment	Set Type	Set No. ※	

統NISSAN MOTOR CO., LTD. 日産自動車(株)

○——ディーゼル車 Diesel-engine Automobiles

※(): OLD SET No.

YD25DDT1	2500		4	1	89 × 2 × 3.1		GN	SM	23265	12033-VK510	
				2	89 × 2 × 3.5						IST=HALF KEYSTONE
				0	89 × 3 × 2		GN				
				1	89 × 2 × 3.1		GN	SM	23960	12033-VK520	
2	89 × 2 × 3.5		Cr1								
0	89 × 3 × 2		GN			IST=HALF KEYSTONE					
SD23 SD25	2494	●Datsun Truck	4	1	89 × 2.5 × 3.7	RN		FX	23690 (24750) (25380)	12033-L2003	
				2	89 × 2 × 3.7	RN					12033-L2002
				0	89 × 4.5 × 3.2						12033-L2000
SD23 SD25	2494	●Datsun Truck	4	1	89 × 2.5 × 3.7	RN		FX	23840 (24980)	12033-L2006	
				2	89 × 2 × 3.7	RN					
				0	89 × 4.5 × 3.2						
TD23	2494	●Datsun Truck	4	1	89 × 2.5 × 3.7	RN		FM	23714 (24714) (24712)	12033-02N10	
				2	89 × 2 × 3.7	RN					12033-02N00
				0	89 × 4 × 3.2						12033-02N11
TD25 AD-4	2494	●Datsun Truck	4	1	92.9 × 2.5 × 4	RN	Cr4	FM	23920 (34042)	12033-44G10	
				2	92.9 × 2 × 4	RN					
				0	92.9 × 4 × 2.5						
TD25T1			4	1	92.9 × 2.5 × 3.8		GN	SM	23385	12033-3S910	
				2	92.9 × 2 × 4	RN					
				0	92.9 × 3 × 2.5		GN				IST=HALF KEYSTONE
TD27 AD-2	2700	●Datsun Truck ●Caraban	4	1	96 × 2.5 × 4	RN		FM	23892 (24892) (24891) (24893)	12033-43G10	
				2	96 × 2 × 4	RN					12033-43G11
				0	96 × 4 × 2.5						
TD27T AD27T	2700		4	1	96 × 2.5 × 3.8		GN	SM	23183	12033-37N10	
				2	96 × 2 × 4.0	RN					
				0	96 × 4 × 2.5		GN				IST=KEYSTONE
TD27T AD-2T	2700	●Datsun Truck ●Caraban	4	1	96 × 2.5 × 3.8		GN	SM	23995 (24995)	12033-31N11	
				2	96 × 2 × 4						
				0	96 × 4 × 2.5		GN				IST=HALF KEYSTONE
TD27 AD-2	2700		4	1	96 × 2.5 × 4	RN		FM	23307 (24307)	12033-6T010	
				2	96 × 2 × 4	RN					
				0	96 × 3 × 2.5		GN				
TD27	2700	●Datsun Truck ●Caraban	4	1	96 × 2.5 × 4	RN		FM	23032	12033-6T011	
				2	96 × 2 × 4	RN					
				0	96 × 3 × 2.5		GN				
TD42 AD-3	4169	●Datsun Jeep KD	6	1	96 × 2.5 × 4	RN		FM	23941 (24941) (24901)	12033-06J10	
				2	96 × 2 × 4	RN					
				0	96 × 4 × 2.5						
TD42	4200	●Civilian ●Safari	6	1	96 × 2.5 × 3.7		GN	SM	23033	12033-WJ11A	
				2	96 × 2 × 4	RN					
				0	96 × 3 × 2.5		GN				IST=HALF KEYSTONE
TD42T AD-3T	4169	●Datsun Jeep KD	6	1	96 × 2.5 × 4	RN		FM	23305 (24305)	12033-06J15	
				2	96 × 2 × 4	RN					
				0	96 × 3 × 2.5		GN				
エンジン型式	排気量	車名・型式	シリン ダー数	位置	サイズ 径×中×厚さ	材質	表面改質	セットタイプ	セットNo.	備考	
ピストンリング											

Engine Type	cc	Vehicle Model Chassis Type	Cyl. No.	Piston Ring						Remarks
				Position	Size (mm) d ₁ ×h ₁ ×a ₁ (D×B×T)	Material	Surface Treatment	Set Type	Set No.※	

統NISSAN MOTOR CO., LTD. 日産自動車(株)

○——ディーゼル車 Diesel-engine Automobiles

※(): OLD SET No.

TD42T	4169	●Datsun	6	1	96 × 2.5 × 3.8	RN	GN	SM	23044	12033-05D01	
				2	96 × 2.0 × 4.0		Cr1			IST=HALF KEYSTONE	
				0	96 × 4.0 × 2.5		GN				
Y61 ZD30CTI			4	1	96 × 2.5 × 3.8		GN	SM	23177	A2033-DB010	
				2	96 × 2 × 3.9		GN			IST=HALF KEYSTONE	
				0	96 × 2 × 2						
ZD30 TD27-3			4	1	96 × 2 × 3.1		GN	SM	23014	12033-VW211	
				2	96 × 1.2 × 2.95		GN			12033-VW210	
				0	96 × 2 × 2						
WX951 ZD30 BD30			4	1	96 × 2.5 × 3.8		GN	SX	23176	12033-2W211	
				2	96 × 2 × 4		GN			12033-0W813	
				0	96 × 3 × 2.5						IST=HALF KEYSTONE
ED30	2956	●Bus CYHT40, CYHWT40, GYC240, GHYC240	4	1	98 × 3 × 4.2	RN		FX	23040 (24040)	12033-J2001	
				2	98 × 2 × 4.2					12033-J2002	
				3	98 × 2 × 4.2					12033-J2004	
		●Truck YC230, DYC240, HYC240, DEYC240, JVYC240, Y40, EYT40, TWT40, DYWT40		4	0	98 × 4.5 × 3.1		GN	FX	23660 (24660)	12033-J2008
					1	98 × 3 × 4.2					12033-J5571
					2	98 × 2 × 4.2					12033-J5572
0	98 × 4.5 × 3.1	GN	12033-J5574								
									12033-J5576		
QD32NA AD5	3200	●Caraban ●Datsun Truck	4	1	99.2 × 2.5 × 3.8	RN	GN	SM	23985	12033-2S610	
				2	99.2 × 2 × 4.1		GN				
				0	99.2 × 3 × 2.5						
QD32			4	1	99.2 × 2.5 × 3.8		GN	SM	23007	12033-1W411	
				2	99.2 × 2 × 4.1		GN			IST=HALF KEYSTONE	
				0	99.2 × 3 × 2.5						
QD32Ti	3200	●Datsun Truck ●Caraban	4	1	99.2 × 2.5 × 3.7	RN		SM	23034	12033-1W412	
				2	99.2 × 2 × 4.1					GN	IST=HALF KEYSTONE
				0	99.2 × 3 × 2.5						
ED33(New)	3300	●Truck ●Datsun Truck	4	1	100 × 3 × 4.2	RN		FX	23000 (23940) (25880)	12033-J6500	
				2	100 × 2 × 4.2					12033-J6501	
				0	100 × 4.5 × 3.2					12033-T9000	
									12033-T9304		
ED33(New)	3300	●Datsun Truck	4	1	100 × 2 × 4	RN		FM	23015 (24015)	12033-T9306	
				2	100 × 2 × 4.2						
				0	100 × 4 × 2.5						
FD33T	3298	●Datsun Truck	4	1	100 × 3 × 4.2	RN	Cr2	FX	23910 (24910)	12033-T9302	
				2	100 × 2 × 4.2					12033-T9308	
				0	100 × 4.5 × 3.2					IST=HALF KEYSTONE	
				1	100 × 3 × 4.2	RN	Cr1	FX	23084 (25084)		IST=HALF KEYSTONE
				2	100 × 2 × 4.2						
				0	100 × 4.5 × 3.2						
ED35	3500	●Datsun Truck	4	1	102.5 × 3 × 4.3	RN	Cr4	FM	23025 (34025)	12033-56T10	
				2	102.5 × 2 × 4.2						
				0	102.5 × 4 × 2.5						
エンジン型式	排気量	車名・型式	シリン ダー数	位置	サイズ 径×巾×厚さ	材質	表面改質	セットタイプ	セットNo.	備考	
ピストンリング											

Engine Type	cc	Vehicle Model Chassis Type	Cyl. No.	Piston Ring						Remarks
				Position	Size (mm) d ₁ ×h ₁ ×a ₁ (D×B×T)	Material	Surface Treatment	Set Type	Set No. ※	

統 NISSAN MOTOR CO., LTD. 日産自動車(株)

○ ————ディーゼル車 Diesel-engine Automobiles

※ (): OLD SET No.

FD35	3465	●Condore	4	1	102.5 × 2 × 3.9	RN		FM	23475	12033-01T10	
				2	102.5 × 2 × 4.2				(34475)		
				0	102.5 × 4 × 2.5				(34020)		
FD35T	3465	●Condore	4	1	102.5 × 3 × 4.2	RN	Cr2	FM	23052	12033-01T60	
				2	102.5 × 2 × 4.2				(34052)		
				0	102.5 × 4 × 2.5						IST=HALF KEYSTONE
				1	102.5 × 3 × 4.2	RN	Cr1	FM	23055	IST=HALF KEYSTONE	
				2	102.5 × 2 × 4.2				(34055)		
				0	102.5 × 4 × 2.5						
FD3	4214	●Aerasu	4	1	108 × 3 × 4.3	RN		FM	23975	12033-0T000	
				2	108 × 2 × 4.5				(34975)	12033-0T010	
				0	108 × 4 × 2.5						
FD42	4200	●ATLAS	4	1	108 × 3 × 3.8		GN	SM	23038	12033-0T060	
				2	108 × 2 × 4.5						Cr1
				0	108 × 4 × 2.5						GN
FD46T	4617	●Condore	4	1	108 × 2.5 × 3.7		GN	SM	23054	12033-31D03	
				2	108 × 2.0 × 4.5					Cr1	
				0	108 × 3.0 × 2.0					GN	IST=HALF KEYSTONE
エンジン型式	排気量	車名・型式	シリンダー数	位置	サイズ 径×巾×厚さ	材質	表面改質	セットタイプ	セットNo.	備考	
ピストンリング											

Engine Type	cc	Vehicle Model Chassis Type	Cyl. No.	Piston Ring						Remarks
				Position	Size (mm) d ₁ ×h ₁ ×a ₁ (D×B×T)	Material	Surface Treatment	Set Type	Set No. ※	

●NISSAN DIESEL CO., LTD. 日産ディーゼル工業(株)

○——ディーゼル車 Diesel-engine Automobiles

※(): OLD SET No.

ED6 FD6	6000	●Truck CM80, CM85, TK80, CM90,CK85 ●Bus R80, RM80		1	100 × 3 × 4.2	RN		FX	24120	12040-Z5027	
				2	100 × 2 × 4.2					1cyl. 12040-Z5001	
				3	100 × 2 × 4.2					12040-Z5025	
				0	100 × 4.5 × 3.2					1cyl. 12040-Z5026	
				1	100 × 3 × 4.2	RN		FX	24260	12040-Z5028	
				2	100 × 2 × 4.2					1cyl. 12040-Z5005	
				0	100 × 4.5 × 3.2						
FD6T	6000	●Truck CM80, CM85, TK80, CM90,CK85 ●Bus R80, RM80		1	100 × 3 × 4.2	RN		FX	24130	12040-Z5526	
				2	100 × 2 × 4.2					12040-Z5525	
				3	100 × 2 × 4.2				1ST=KEYSTONE		
				0	100 × 4.5 × 3.2						
				1	100 × 3 × 4.2	RN		FX	24180	12040-Z5527	
				2	100 × 2 × 4.2						
				3	100 × 2 × 4.2						
				0	100 × 4.5 × 3.2					1ST=HALF KEYSTONE	
				1	100 × 3 × 4.2	RN		FX	24140	12040-Z5528	
				2	100 × 2 × 4.2					12040-Z5501/cyl.	
				0	100 × 4.5 × 3.2					1ST=HALF KEYSTONE	
FM6T				1	105.9 × 2.5 × 3.8		GN	SM	24000 (34180)	12040-Z5508/cyl.	
				2	105.9 × 2 × 4.5						
				0	105.9 × 4 × 2.5						
FE6	7000	●Truck MK210, CM89, CM87		1	108 × 3 × 4.3	RN		FM	24031 (34920)	12040-Z5211	
				2	108 × 2 × 4.5						
				0	108 × 4 × 2.5						
FE6	7000	MK250		1	108 × 3 × 4.3	RN		FX	24091 (34091) (34920)	12040-Z5511	
				2	108 × 2 × 4.5					12040-Z5504	
				0	108 × 4 × 2.5						
FE6T	7000	MK250		1	108 × 3 × 4.3	RN		FM	24951 (34950) (24950)	12040-Z5505/cyl.	
				2	108 × 2 × 4.5					12040-Z5512	
				0	108 × 4 × 2.5				12040-Z5517		
										1ST=HALF KEYSTONE	
FE6TA	7000	MK250		1	108 × 3 × 4.3	RN		FX	24095 (34093) (24093)	12040-Z5517/cyl.	
				2	108 × 2 × 4.5					1ST=HALF KEYSTONE	
				0	108 × 4 × 2.5						
				1	108 × 2.5 × 3.8		GN	SM	24080 (34872)	12040-Z5519	
				2	108 × 2 × 4.5					12040-Z5560	
				0	108 × 4 × 2.5		GN			12040-Z5561	
										12040-Z5564	
										1ST=HALF KEYSTONE	
FE6T-2	7000		6	1	108 × 2.5 × 3.3			Cr1	SM	24004	12040-Z5608
				2	108 × 2.0 × 3.3						
				0	108 × 3.0 × 2.5			GN		1ST=HALF KEYSTONE	
A500FET				1	108 × 2.5 × 3.8			GN	SM	24100 (34840)	12040-Z5561/cyl.
				2	108 × 2 × 4.5						
				0	108 × 4 × 2.5			GN		1ST=HALF KEYSTONE	
エンジン型式	排気量	車名・型式	シリンダー数	位置	サイズ 径×中×厚さ	材質	表面改質	セットタイプ	セットNo.	備考	
ピストンリング											

Engine Type	cc	Vehicle Model Chassis Type	Cyl. No.	Piston Ring						Remarks
				Position	Size (mm) d ₁ ×h ₁ ×a ₁ (D×B×T)	Material	Surface Treatment	Set Type	Set No. ※	

統 NISSAN DIESEL CO., LTD. 日産ディーゼル工業(株)

○——ディーゼル車 Diesel-engine Automobiles

※(): OLD SET No.

ND6	7000	●Truck ●Bus CK10, PRX102		1	110 × 4 × 4.4	RN		FX	24810	12040-90127		
				2	110 × 3 × 4.4					12040-95006		
				0	110 × 5 × 3.5	RN						
ND6T	7000	●Truck ●Bus CK10, PRX102	6	1	110 × 4 × 4.4			FX	24190	12040-90326		
				2	110 × 3 × 4.4					12040-95028		
				0	110 × 5 × 3.5					1ST=KEYSTONE		
NE	7412	●Big Thumb	6	1	110 × 4 × 4.4	RN		FX	24800	12040-95010		
				2	110 × 3 × 4.4							
				0	110 × 5 × 3.5							
NE6	7000	●Truck	6	1	110 × 3 × 3.9	RN		FM	24541	12040-95013		
				2	110 × 2.5 × 3.9	RN						
				0	110 × 4 × 2.5							
			6	1	110 × 3 × 3.9	RN		FX	24110 (34980)	12040-95026		
				2	110 × 2.5 × 3.9							
				0	110 × 5 × 3.5							
			6	1	110 × 3 × 3.9	RN		FM	24160 (34010)	12040-95125		
				2	110 × 2.5 × 3.9	RN				12040-95014/cyl.		
				0	110 × 4 × 2.5					1ST=HALF KEYSTONE		
NE6TA	7000	●Truck	6	1	110 × 3 × 3.9	RN		FM	24061 (34061)	12040-95016		
				2	110 × 2.5 × 3.9	RN						
				0	110 × 4 × 2.5		GN			1ST=HALF KEYSTONE		
NF6TA	9160	CD320	6	1	120 × 3 × 4.3	RN	GN	SM	24585	12040-95501		
				2	120 × 2.5 × 4.7							
				0	120 × 4 × 2.5		GN			1ST=HALF KEYSTONE		
PD6	10000	●Truck ●Bus CK20, TK20, CD40, CV40, PT81, CW40, M20, CB20, TFA21, CW41	6	1	125 × 5 × 5.2	RN		FX	24340	12040-90026		
				2	125 × 3.5 × 5.2					12040-90029		
				0	125 × 5 × 3.5					12040-96004		
										12040-96026		
										12040-96127		
										12040-96226		
				6	1	125 × 4 × 5.2	RN			FX	24250 (24170) (34170)	12040-96010/cyl.
					2	125 × 3.5 × 5.2						1ST=HALF KEYSTONE
					0	125 × 5 × 3.5						
6	1	125 × 4 × 5.2	RN		FX	24320	12040-96129					
	2	125 × 3.5 × 5.2					12040-96125					
	0	125 × 5 × 3.5					12040-96005/cyl. 12040-90228 1ST=KEYSTONE					
MD92TCI	9203	●Big Thumb	6	1	125 × 2.5 × 4.3		GN	SM	24003	12040-Z6002		
				2	125 × 2.0 × 3.9		GN			12040-Z6004		
				0	125 × 3.0 × 2.0		GN			1ST=HALF KEYSTONE		
PN6TA		●Truck ●Bus	6	1	132.9 × 2.5 × 4.8		GN	SM	24170 (34070)	12040-96567/cyl.		
				2	132.9 × 2.5 × 5.5							
				0	132.9 × 4 × 2.5					1ST=KEYSTONE		
エンジン型式	排気量	車名・型式	シリンダー数	位置	サイズ 径×中×厚さ	材質	表面改質	セットタイプ	セットNo.	備考		
ピストンリング												

Engine Type	cc	Vehicle Model Chassis Type	Cyl. No.	Piston Ring					Remarks
				Position	Size (mm) d ₁ ×h ₁ ×a ₁ (D×B×T)	Material	Surface Treatment	Set Type	

統NISSAN DIESEL CO., LTD. 日産ディーゼル工業(株)

○——ディーゼル車 Diesel-engine Automobiles

※(): OLD SET No.

PE6	12000	●Truck ●Bus CK20, TK20, CD40, CV40, PT81, CW40, M20, CB20, TFA21, CW41	6	1	133 × 4 × 5.2	RN		FX	24300	12040-90025
				2	133 × 3.5 × 5.5					12040-96128
				0	133 × 6 × 4.2					12040-96028 12040-96225/cyl. 12040-90053/cyl. 1ST=KEYSTONE
PE6T	12000	●Truck ●Bus CK20, TK20, CD40, CV40, PT81, CW40, M20, CB20, TFA21, CW41	6	1	133 × 4 × 5.3	RN		FX	24570	12040-96513
				2	133 × 3.5 × 5.5					12040-96504
				0	133 × 6 × 4.2					12040-96509/cyl. 12040-965181/cyl.
			6	1	133 × 3 × 3.1	RN		FM	24420 (34420)	12040-96517/cyl.
				2	133 × 2.5 × 5.5					1ST=HALF KEYSTONE
				0	133 × 4 × 2.5					
PF6 PF6T	13000	●Truck	6	1	133 × 2.5 × 4.8		GN	SM	24510 (34510)	12040-96564/cyl.
				2	133 × 2.5 × 5.5					12040-96566
				0	133 × 4 × 2.5					12040-96570 1ST=HALF KEYSTONE
RE10	18894	●Truck CW610	10	1	135 × 3 × 5.1	RN		FX	24220 (34220)	12040-97326
				2	135 × 3 × 5.5					12040-97626
				0	135 × 5 × 3					
RD8	15000	●Truck ●Bus CV50, CW51, CW52, CD52, WD18, WD151, TWA52, RA50, RA51, CV56	8	1	135 × 4 × 5.1	RN		FX	24780	12040-97126
				2	135 × 3 × 5.5					12040-97026
				0	135 × 6 × 4					12040-97025 12040-97226 12040-97028 12040-90325
			8	1	135 × 4 × 5.5	RN		FX	24370	12040-97128
				2	135 × 3 × 5.5					12040-97528
				0	135 × 6 × 4					1ST=KEYSTONE
RD10	14313	●Truck CK60, CW60, CW61, WD23, WG30	10	1	135 × 4 × 5.1	RN		FX	24760	12040-97127
				2	135 × 3 × 5.5					12040-97229
				0	135 × 6 × 4					12040-97227 12040-97527
RD8T RD10T	17892	●Truck WP381	8 10	1	135 × 4 × 5.5	RN		FM	24162	12040-97073
				2	135 × 3 × 5.5					12040-97076/cyl.
				0	135 × 5 × 3					1ST=KEYSTONE
RD10T	17892	●Truck WP381	10	1	135 × 4 × 5.5	RN		FX	24380	12040-97329
				2	135 × 3 × 5.5					1ST=KEYSTONE
				0	135 × 6 × 4					
RE8	15000	CW53, CD53, CW510	8	1	135 × 3 × 5.1	RN		FM	24790	12040-97068
				2	135 × 3 × 5.5					12040-97012/cyl.
				0	135 × 5 × 3					
エンジン型式	排気量	車名・型式	シリン ダー数	位置	サイズ 径×中×厚さ	材質	表面改質	セットタイプ	セットNo.	備考
ピストンリング										

Engine Type	cc	Vehicle Model Chassis Type	Cyl. No.	Piston Ring						Remarks
				Position	Size (mm) d ₁ ×h ₁ ×a ₁ (D×B×T)	Material	Surface Treatment	Set Type	Set No. ※	

統 NISSAN DIESEL CO., LTD. 日産ディーゼル工業(株)

○—ディーゼル車 Diesel-engine Automobiles

※ (): OLD SET No.

RE8	15000	CW53, CD53, CW510	8	1	135 × 3 × 5.5	RN		FX	24830	12040-97325
				2	135 × 3 × 5.5					12040-97427/cyl.
				0	135 × 5 × 4					12040-97625/cyl. 12040-97061/cyl.
RE10T	18894	CW66, CK66, CK67T	10	1	135 × 4 × 5.5	RN		FX	24440	12040-97428
				2	135 × 3 × 5.5					12040-97065/cyl.
				0	135 × 5 × 4					1ST=KEYSTONE
GE13	13074	●Big Thumb	6	1	136 × 2.5 × 3.8		GN	SM	24002	12040-00Z0A
				2	136 × 2.0 × 3.7		Cr1			
				0	136 × 3.0 × 2.5		GN			1ST=HALF KEYSTONE
RF8	16991	CD520	8	1	138 × 2.5 × 5.2	RN		FX	24001	12040-97072
				2	138 × 2.5 × 5.6	RN				
				0	138 × 4 × 2.8					
RFT	16991			1	138 × 3 × 4.9			SM	24335	12040-97101/cyl.
				2	138 × 2.5 × 5.6					
				0	138 × 4 × 2.5					1ST=HALF KEYSTONE
RG8	17990	CW530	8	1	142 × 3 × 4.8		GN	SM	24921	12040-97103
				2	142 × 2.5 × 5.7		GN			
				0	142 × 4 × 2.5					
RH.8.10	21205	●Tractor		1	150 × 3 × 4.9	RN	GN	SM	24265	12040-97105/cyl.
				2	150 × 2.5 × 5.6		GN			
				0	150 × 4 × 2.5					
エンジン型式	排気量	車名・型式	シリンダー数	位置	サイズ 径×巾×厚さ	材質	表面改質	セットタイプ	セットNo.	備考
ピストンリング										

Engine Type	cc	Vehicle Model Chassis Type	Cyl. No.	Piston Ring						Remarks
				Position	Size (mm) d ₁ ×h ₁ ×a ₁ (D×B×T)	Material	Surface Treatment	Set Type	Set No. ※	

●TOYOTA MOTOR CORP. トヨタ自動車(株)

○——ガソリン車 Gasoline-engine Automobiles

※(): OLD SET No.

1SZ			4	1	69 × 1.2 × 2.3			SV	28067	13011-23051
				2	69 × 1.2 × 2.8					
				0	69 × 2 × 2.2					
1SZ-FE	997	●Vitz ●PLATZ	4	1	69 × 1.2 × 2.3		Cr1	SV	28018	13011-23041
				2	69 × 1.2 × 2.8					
				0	69 × 2 × 2.2					
IE-L	1000	●Starlet	4	1	70.5 × 1.5 × 2.7		GN	SV	28035	13011-10070 13011-10080 13011-10081
				2	70.5 × 1.5 × 2.9					
				0	70.5 × 3 × 3					
2K	993	●Publica PK30, 36, 36V, 40, 95	4	1	72 × 2 × 3.4			FV	28590	13011-12030, 31 13011-12010
				2	72 × 2 × 3.4					
				0	72 × 4 × 3.4					
2SZ-FE	1296	●Vitz ●Ractis ●Belta	4	1	72 × 1.2 × 2.3		GN	SV	28047	13011-23060
				2	72 × 1.2 × 2.6					
				0	72 × 2.0 × 2.2					
2E, 3E	1300	●Corolla R-EE106V	4	1	73 × 1.5 × 2.8			SV	28971 (28980)	13011-11040,11041 13011-11060 13011-11061 13011-11090 13011-11080
				2	73 × 1.5 × 3.1					
				0	73 × 3 × 2.8					
2E-2	1295		4	1	73 × 1.5 × 2.8		GN	SV	28012	13011-11064
				2	73 × 1.5 × 3.1					
				0	73 × 3 × 2.65					
4E-FE	1331	●Corolla	4	1	74 × 1.2 × 2.7			SV	28804	13011-11122
				2	74 × 1.2 × 3.1					
				0	74 × 3 × 2.6					
5E	1300	●Starlet	4	1	74 × 1.2 × 2.8			SV	28705 (28620)	13011-11140 13011-11160
				2	74 × 1.2 × 3.1					
				0	74 × 3 × 2.6					
IN-T	1500	●Starlet	4	1	74 × 1.5 × 2.7			SV	28243	13011-55010 13011-55011 IST=HALF KEYSTONE
				2	74 × 1.5 × 3.2					
				0	74 × 3 × 2.8					
K 3K	1077 1166	●Corolla 1200 ●Corolla ●Publica ST	4	1	75 × 2 × 3.6			FV	28510	13011-24010,11,12 13011-22011 13011-24020, 23 13011-24030
				2	75 × 2 × 3.6					
				0	75 × 4 × 3.6					
M, 2M	1988	●Crown 2000 MS41, MS50, MS52. MS56, MS46	6	1	75 × 2 × 3.6	RN		FV	28480	13011-41015 13011-41040
				2	75 × 2 × 3.6					
				0	75 × 4 × 3.6					
4K(New)	1290	●Corolla ●Sprinter ●Starlet	4	1	75 × 1.5 × 3.2	RN		FV	28940	13011-13010 13011-13060
				2	75 × 1.5 × 3.4					
				0	75 × 4 × 3.6					
4K-C	1290	●Publica 1000,KE10 ●Starlet 1200 ●Sprinter 1200 ●Corolla 1200	4	1	75 × 2 × 3.1		RF	FV	28851	13011-13030
				2	75 × 2 × 3.4					
				0	75 × 4 × 3.1					
エンジン型式	排気量	車名・型式	シリン ダー数	位置	サイズ 径×中×厚さ	材質	表面改質	セットタイプ	セットNo.	備考
ピストンリング										

Engine Type	cc	Vehicle Model Chassis Type	Cyl. No.	Piston Ring						Remarks
				Position	Size (mm) d ₁ ×h ₁ ×a ₁ (D×B×T)	Material	Surface Treatment	Set Type	Set No. ※	

統 TOYOTA MOTOR CORP. トヨタ自動車(株)

○——ガソリン車 Gasoline-engine Automobiles

※(): OLD SET No.

1G	1988	●Soarer ●Crown ●Mark II ●Chaser ●Cresta	6	1	75 × 1.5 × 3.2	RN		FV	28690	13011-70010
				2	75 × 1.5 × 3.4					13011-70030
				0	75 × 4 × 3					
1G-G	1988	●Soarer ●Crown ●Mark II	6	1	75 × 1.2 × 3.3		GN	SV	28960	13011-70070
				2	75 × 1.5 × 3.3		13011-70040			
				0	75 × 4 × 3.1		GN			13011-70061
1G-GEu			6	1	75 × 1.2 × 3.25			SV	28963	13011-88300
				2	75 × 1.5 × 3.3					
				0	75 × 2.8 × 2.8					
1GX 1G-GE	2000	●Crown ●Mark II ●Cresta	6	1	75 × 1.2 × 3.3		GN	SV	28061	13011-70051
				2	75 × 1.5 × 3.3		Cr1			
				0	75 × 4.0 × 3.1		GN			
1NZ-FXE	1496	●Prius	4	1	75 × 1.2 × 2.5		Cr1	SM	28032	13011-21030
				2	75 × 1.2 × 2.8		13011-21070			
				0	75 × 2 × 2		GN			
2NZ-FE		●Vitz ●Funcargo	4	1	75 × 1.2 × 2.5		GN	SV	28125	13011-21050
				2	75 × 1.2 × 2.8		13011-21041			
				0	75 × 2 × 2.55					
2NZ-FE2	1298	●YARIS ●Vitz ●Funcargo	4	1	75 × 1.2 × 2.5		GN	SV	28003	13011-21060
				2	75 × 1.2 × 2.5					
				0	75 × 3 × 2.5		GN			
2A	1295	●Tercel ●Corsa	4	1	76 × 2 × 3.6		Cr4	FV	28070	13011-14010,14011
				2	76 × 2 × 3.6		13011-14020			
				0	76 × 4 × 3.1		13011-14021			
3P, 4P	1345	●Hi-Ace PH10, PH10-B, PH10-D, PH10-V, PH10P, PH10SV ●Corona Van PT47V, PT47V-F ●Toyoace PK32, PK32-B	4	1	76.6 × 2 × 3.5			FV	28500	13011-23030
				2	76.6 × 2 × 3.5					13011-23010
				0	76.6 × 4 × 3.5					
R	1453	●Crown RS20, RA21 ●Corona PT20 ●Masterline RS26, RS26P, RS26V ●Dyna RK85, RK95	4	1	77 × 2.5 × 3.4			FV	28440	13011-39020
				2	77 × 2.5 × 3.4					
				0	77 × 4 × 3.4					
1A, 3A	1452	●Stout RK45, RK35 ●Toyoace RK40	4	1	77.5 × 1.5 × 3.2	RN		FV	28200	13011-15010
				2	77.5 × 1.5 × 3.2					13011-15011
				0	77.5 × 2.8 × 2.75					13011-15020
エンジン型式	排気量	車名・型式	シリン ダー数	位置	サイズ 径×中×厚さ	材質	表面改質	セットタイプ	セットNo.	備考
ピストンリング										

TOYOTA MOTOR CORP.
トヨタ自動車(株)

Engine Type	cc	Vehicle Model Chassis Type	Cyl. No.	Piston Ring						Remarks
				Position	Size (mm) d ₁ ×h ₁ ×a ₁ (D×B×T)	Material	Surface Treatment	Set Type	Set No. [※]	

統 TOYOTA MOTOR CORP. トヨタ自動車(株)

○——ガソリン車 Gasoline-engine Automobiles

※(): OLD SET No.

1A, 3A	1452		4	1	77.5 × 1.5 × 3.1		RF	SV	28330	13011-15031
				2	77.5 × 1.5 × 3.4					
				0	77.5 × 2.8 × 2.8					
			4	1	77.5 × 1.5 × 3.1			SV	28699	
				2	77.5 × 1.5 × 3.4					
				0	77.5 × 2.8 × 2.8					
2R	1490	<ul style="list-style-type: none"> ●Corona RT40, RT50, PT56, RT46V ●Bus RH15B ●Stout RK43, RK47, RK47P, RK47V ●Toyoace PK41, PK41P, PK41V ●Hi-Lux RN10, R10D 	4	1	78 × 2 × 3.7			FV	28470	13011-31030 13011-31040
				2	78 × 2.5 × 3.7					
				0	78 × 4 × 3.6					
5A-F	1498	●Corolla	4	1	78.7 × 1.5 × 2.8			SV	28244	13011-15050
				2	78.7 × 1.5 × 3.4					
				0	78.7 × 3 × 3					
5A-F	1498	●Corolla	4	1	78.7 × 1.2 × 2.8			SV	28019	13011-15100 13011-15120
				2	78.7 × 1.5 × 3.4					
				0	78.7 × 3 × 2.8					
8A-FE			4	1	78.7 × 1.2 × 2.7		GN	SV	28853	13011-15130
				2	78.7 × 1.5 × 3.0					
				0	78.7 × 3 × 2.65					
1ZZ	1800	●Corolla	4	1	79 × 1.2 × 2.7			SV	28785	13011-22030 13011-22040 13011-22150 -22100,22111 -22200
				2	79 × 1.2 × 3.2					
				0	79 × 3 × 2.5					
			4	1	79 × 1.2 × 2.7			SV	28400	13011-22090
				2	79 × 1.2 × 3.2					
				0	79 × 3 × 2.5					
T	1407	<ul style="list-style-type: none"> ●Corolla 1400 ●Carina 1400 ●Celica 	4	1	80 × 2 × 3.7	RN		FV	28020	13011-25010 13011-25041 13011-25020 -25032
				2	80 × 2 × 3.7					
				0	80 × 4 × 3.4					
T-U	1407	<ul style="list-style-type: none"> ●Corolla ●Starlet 	4	1	80 × 1.5 × 3.7		Cr4	FV	28290	13011-25042 -25033
				2	80 × 2 × 3.7					
				0	80 × 4 × 3.6					
4M	2563	<ul style="list-style-type: none"> ●Crown 2600 MS65, 75, 83, 85, 95 	6	1	80 × 2 × 3.8			FV	28010	13011-45021 13011-45040
				2	80 × 2 × 3.8					
				0	80 × 4 × 3.7					
エンジン型式	排気量	車名・型式	シリン ダー数	位置	サイズ 径×中×厚さ	材質	表面改質	セットタイプ	セットNo.	備考
ピストンリング										

Engine Type	cc	Vehicle Model Chassis Type	Cyl. No.	Piston Ring						Remarks
				Position	Size (mm) d ₁ ×h ₁ ×a ₁ (D×B×T)	Material	Surface Treatment	Set Type	Set No. ※	

統 TOYOTA MOTOR CORP. トヨタ自動車(株)

○——ガソリン車 Gasoline-engine Automobiles

※(): OLD SET No.

12R	1587	●Corona Hi-luxe, Hi-Van ●Corona-Van ●Toyoace	4	1	80.5 × 2 × 3.9		Cr4	FV	28835	13011-31091				
				2	80.5 × 2 × 3.9					13011-31070				
				0	80.5 × 4 × 3.8					13011-31061				
				1	80.5 × 2 × 3.9					RN	Cr1	FV	28810	
				2	80.5 × 2 × 3.9									
				0	80.5 × 4 × 3.8									
				1	80.5 × 2 × 3.9					RN	Cr1	FV	28818	
				2	80.5 × 2 × 3.9									
				0	80.5 × 4 × 3.8									
1SL, 1S-U	1832	●Corona ●Corolla	4	1	80.5 × 1.5 × 3.3			SV	28750	13011-63010				
				2	80.5 × 1.5 × 3.7					13011-63011				
				0	80.5 × 4 × 3.1					13011-63020				
13011-63030, 31														
5K	1486	●Camry ●Carina	4	1	80.5 × 1.5 × 3.3		GN	SV	28867	13011-13040				
				2	80.5 × 1.5 × 3.65					13011-13050				
				0	80.5 × 4 × 3.1					13011-13090				
GN														
7K	1486	●Camry ●Carina	4	1	80.5 × 1.5 × 3.3		GN	SV	28998	13011-13100				
				2	80.5 × 1.5 × 3.65									
				0	80.5 × 4 × 2.8					GN				
7AF2	1800	●Corolla	4	1	81 × 1.2 × 2.8			SV	28093	13011-16340				
				2	81 × 1.5 × 3.4									
				0	81 × 3 × 2.65									
7AF	1800	●Corolla	4	1	81 × 1.2 × 2.8			SV	28331	13011-16300				
				2	81 × 1.5 × 3.4									
				0	81 × 3 × 2.7									
7A-FE	1762	●Carina ●Corona ●Premio	4	1	81 × 1.2 × 2.8		GN	SV	28672	13011-16320				
				2	81 × 1.5 × 3.4					13011-16330				
				0	81 × 3 × 2.7					GN				
4A	1587	●Corolla ●Sprinter	4	1	81 × 1.5 × 3.3			SV	28560	13011-16010				
				2	81 × 1.5 × 3.6					13011-16011				
				0	81 × 2.8 × 2.8									
4A	1587	●Corolla AT190, AE101	4	1	81 × 1.5 × 3.3		GN	SV	28902 (28000) (28130)	13011-16030				
				2	81 × 1.5 × 3.6					13011-16032				
				0	81 × 2.8 × 2.8					13011-16031				
GN														
4AG	1587		4	1	81 × 1.2 × 3.1		GN	SV	28221	13011-16190				
				2	81 × 1.5 × 3.6									
				0	81 × 2.8 × 3					GN				
4AG	1600	●Corolla AT190, AE101	4	1	81 × 1.5 × 3.3		RF	SV	28600	13011-16050				
				2	81 × 1.5 × 3.6									
				0	81 × 2.8 × 2.8									
4AGZ	1587		4	1	81 × 1.2 × 3.1		GN	SV	28212	13011-16200				
				2	81 × 1.5 × 3.6					13011-16210				
				0	81 × 2.8 × 2.8									
エンジン型式	排気量	車名・型式	シリンダー数	位置	サイズ 径×中×厚さ	材質	表面改質	セットタイプ	セットNo.	備考				
ピストンリング														

TOYOTA MOTOR CORP.
トヨタ自動車(株)

Engine Type	cc	Vehicle Model Chassis Type	Cyl. No.	Piston Ring						Remarks
				Position	Size (mm) d ₁ ×h ₁ ×a ₁ (D×B×T)	Material	Surface Treatment	Set Type	Set No. ※	

◎TOYOTA MOTOR CORP. トヨタ自動車(株)

○——ガソリン車 Gasoline-engine Automobiles

※(): OLD SET No.

4AGEU	1600	●Corolla AT190, AE101	4	1	81 × 1.5 × 3.3		GN	SV	28210	13011-16090				
				2	81 × 1.5 × 3.6									
				0	81 × 2.8 × 2.8									
4A-F	1600	●Corolla AT190, AE101	4	1	81 × 1.5 × 2.8		GN	SV	28260	13011-16140 13011-16120 13011-16070 13011-16130				
				2	81 × 1.5 × 3.4									
				0	81 × 3 × 3									
								1	81 × 1.5 × 2.8		Cr1	SV	28265	13011-16140 13011-16120 13011-16070
								2	81 × 1.5 × 3.4					
								0	81 × 3 × 3					
								1	81 × 1.2 × 2.8		Cr1	SV	28256	13011-16280 -16290 -16300
								2	81 × 1.5 × 3.4					
								0	81 × 3 × 2.8					
4S	1838		4	1	82.5 × 1.5 × 3.1			SV	28023	13011-74120 13011-74121 13011-74110				
				2	82.5 × 1.5 × 3.8									
				0	82.5 × 4 × 2.8									
5M	2759	●Crown 2800 MS112 ●Celica 2800 MA56	6	1	83 × 2 × 3.8		Cr4	FV	28930	13011-43030 13011-43010				
				2	83 × 2 × 3.8									
				0	83 × 4 × 3.45									
5MGE	2759	●Crown ●Soarer ●Celica	6	1	83 × 1.5 × 3.5	RN		FV	28970	13011-43050 13011-43080				
				2	83 × 1.5 × 3.7									
				0	83 × 4 × 3.1									
5MEU	2759	●Celica XX 2800 MA56	6	1	83 × 2 × 3.1		GN	SV	28325	13011-43030 13011-43031				
				2	83 × 2 × 3.8									
				0	83 × 4 × 2.8									
7MGE 7M-GTE	2954	●Soarer	6	1	83 × 1.5 × 3.3	RN		SV	28806	13011-42010 13011-42011				
				2	83 × 1.5 × 3.7									
				0	83 × 4 × 2.8									
21R	1972	●Corona 2000	4	1	84 × 2 × 3.9		Cr4	FV	28660	13011-37010				
				2	84 × 2 × 3.9									
				0	84 × 4 × 3.1									
21R-C	1972	●Corona 2000 RT133 ●Mark II ●Chaser RX41 ●Celica RA45 ●Camry RA56	4	1	84 × 1.5 × 3.6			SV	28920	13011-37030 13011-37050 13011-37060				
				2	84 × 2 × 3.8									
				0	84 × 4 × 3.45									
21R-C	1972	●Mark II / Cressida	4	1	84 × 1.5 × 3.1		GN	SV	28661	13011-37070 13011-37071				
				2	84 × 1.5 × 3.8									
				0	84 × 4 × 3.1									
								1	84 × 1.5 × 3.1		Cr1	SV	28665	
								2	84 × 1.5 × 3.8					
								0	84 × 4 × 3.1					
エンジン型式	排気量	車名・型式	シリンダー数	位置	サイズ 径×巾×厚さ	材質	表面改質	セットタイプ	セットNo.	備考				
ピストンリング														

Engine Type	cc	Vehicle Model Chassis Type	Cyl. No.	Piston Ring						Remarks
				Position	Size (mm) d ₁ ×h ₁ ×a ₁ (D×B×T)	Material	Surface Treatment	Set Type	Set No. ※	

統 TOYOTA MOTOR CORP. トヨタ自動車(株)

○——ガソリン車 Gasoline-engine Automobiles

※(): OLD SET No.

2S	2000	●Camry SV11	4	1	84 × 1.5 × 3.6		GN	SV	28031	13011-74010
				2	84 × 1.5 × 3.8					13011-74020
				0	84 × 4 × 3.25					13011-74030
2T, 3T	1588	●Corona A-TT10D, 11D ●Carolla ATE41, 21, 27, 47, A-TE31, 37, 41, 47, H-TT106V, TT106V ●Carina TA19V ●Celica TA22, 27, A-TA23,28	4	1	84 × 1.5 × 3.6		Cr1	SV	28007	
				2	84 × 1.5 × 3.8					
				0	84 × 4 × 3.25					
2TU, 3TU	1588	●Carina ●Camry ●Celica	4	1	85 × 2 × 4			FV	28030	13011-26020
				2	85 × 2 × 4					13011-26040
				0	85 × 4 × 3.75					13011-26041 13011-27020
3S-FE	1588	●Carina ●Camry ●Celica	4	1	85 × 1.5 × 3.8	RN	Cr4	FV	28900	13011-28020,30,31,70,71
				2	85 × 1.5 × 3.8					13011-28010
				0	85 × 4 × 3.1					13011-28011 13011-28012
6R 7R 8R	1707 1591 1858	●Corona RT61, 71, 77, 84, 94, RX10, 20, 26, RX16V, RT88V, RT60, 70, 76 ●Corona-Mark II RT62K, 72K, 72H, 72S, 62H	4	1	86 × 2 × 3.9			FV	28580	13011-33030
				2	86 × 2.5 × 3.9					13011-33022
				0	86 × 4 × 3.9					13011-33021 13011-33020 13011-33010
1Y 2Y, 3Y	1600 2000	●Hi-Lux ●Town Ace	4	1	86 × 1.5 × 3.3		GN	SV	28805	13011-71010
				2	86 × 1.5 × 3.9					13011-71020
				0	86 × 4 × 3.15					13011-71030,71033 13011-71040
1RZ	1998	●Hi-Ace RZH102V	4	1	86 × 1.5 × 3.3		GN	SV	28775	13011-75010
				2	86 × 1.5 × 3.6					13011-75020
				0	86 × 4 × 3.1					
1RZ	1998		4	1	86 × 1.75 × 3.3		Cr1	SV	28002	
				2	86 × 1.5 × 3.6					
				0	86 × 4 × 3.1					
1JZ	2500	●Mark II	6	1	86 × 1.5 × 3.3			SV	28011	13011-46030
				2	86 × 1.5 × 3.6					
				0	86 × 4 × 2.8					
エンジン型式	排気量	車名・型式	シリン ダ数	位置	サイズ 径×中×厚さ	材質	表面改質	セットタイプ	セットNo.	備考
ピストンリング										

TOYOTA MOTOR CORP.
トヨタ自動車(株)

Engine Type	cc	Vehicle Model Chassis Type	Cyl. No.	Piston Ring						Remarks
				Position	Size (mm) d ₁ ×h ₁ ×a ₁ (D×B×T)	Material	Surface Treatment	Set Type	Set No. ※	

統 TOYOTA MOTOR CORP. トヨタ自動車(株)

○——ガソリン車 Gasoline-engine Automobiles

※(): OLD SET No.

1JZ-FSE	2491	●Mark II ●Crown	6	1	86 × 1.2 × 2.9		GN	SM	28014	13011-46070
				2	86 × 1.2 × 3.2					
				0	86 × 2 × 2					
2JZ	3000	●Crown ●Aristo ●Supra	6	1	86 × 1.5 × 3.3			SV	28915	13011-46040 13011-46041
				2	86 × 1.5 × 3.8					
				0	86 × 4 × 2.85					
2JZ-FE	2400		6	1	86 × 1.5 × 3.3		GN	SV	28085	13011-46050 13011-46051
				2	86 × 1.5 × 3.8					
				0	86 × 4 × 2.8					
2JZ-D4	2997	●Crown ●Aristo	6	1	86 × 1.2 × 2.7		GN	SM	28058	13011-46060 13011-46061
				2	86 × 1.2 × 3.4					
				0	86 × 2.0 × 2.0					
3S-F, 3S-FE	1998	●Corona SV35, 32, ST182, ST185	4	1	86 × 1.5 × 3.3			SV	28001	13011-74091 13011-74072 13011-74070 13011-74080
				2	86 × 1.5 × 3.7					
				0	86 × 4 × 3.1					
3S-F	1998	●Vista ●Caldina ●Carina ●Corona ●Town Ace ●Lite Ace	4	1	86 × 1.5 × 3.3		GN	SV	28056	13011-74131
				2	86 × 1.5 × 3.8					
				0	86 × 4.0 × 2.8					
3S-FE	1998	●Ipsum ●GAIA	4	1	86 × 1.2 × 2.9		GN	SV	28028	13011-74320 13011-74340 13011-74361
				2	86 × 1.2 × 3.4					
				0	86 × 3 × 2.8					
3SG			4	1	86 × 1.2 × 3.3			SV	28891	13011-88363 13011-88380
				2	86 × 1.5 × 3.7					
				0	86 × 4 × 3.4					
1AZ	1998	●RAV4 ●CALDINA	4	1	86 × 1.2 × 2.7		GN	SV	28013	13011-28120
				2	86 × 1.2 × 3.2					
				0	86 × 2 × 2.5					
1AZ	1998	●Wish	4	1	86 × 1.2 × 2.9	RN	GN	SV	28074	13011-28130
				2	86 × 1.2 × 2.9					
				0	86 × 3.0 × 2.8					
1AZ-D4	2000	●Premio ●Allion ●Cardina ●Wish ●Avensis ●Isis ●Noah ●Voxy	4	1	86 × 1.2 × 2.9		GN	SM	28062	13011-28110 13011-28200
				2	86 × 1.2 × 3.1					
				0	86 × 2.0 × 2.0					
1TR	2000	●Hiace Ban ●Toyo Ace	4	1	86 × 1.2 × 2.7		GN	SM	28052	13011-75100 13011-75120
				2	86 × 1.2 × 3.2					
				0	86 × 2.0 × 2.0					
エンジン型式	排気量	車名・型式	シリン ダー数	位置	サイズ 径×中×厚さ	材質	表面改質	セットタイプ	セットNo.	備考
ピストンリング										

Engine Type	cc	Vehicle Model Chassis Type	Cyl. No.	Piston Ring						Remarks
				Position	Size (mm) d ₁ ×h ₁ ×a ₁ (D×B×T)	Material	Surface Treatment	Set Type	Set No. ※	

統 TOYOTA MOTOR CORP. トヨタ自動車(株)

○——ガソリン車 Gasoline-engine Automobiles

※(): OLD SET No.

3S-FES	2000		4	1	86 × 1.2 × 2.9		GN	SM	28995	13011-74400
				2	86 × 1.2 × 3.5					
				0	86 × 2 × 2					
5S-FE		●Nadia ●Town-Ace ●Lite Ace	4	1	87 × 1.2 × 2.85		GN	SV	28913	13011-74370 13011-74380
				2	87 × 1.2 × 3.4					
				0	87 × 3 × 2.5					
5S-FE	2163	●Camry ●Harrier	4	1	87 × 1.5 × 3.55		Cr1	SV	28054	13011-74150
				2	87 × 1.5 × 3.6					
				0	87 × 3.0 × 2.65					
5S	2200	●Camry	4	1	87 × 1.5 × 3.55		GN	SV	28683	13011-74290 13011-74260 13011-74261 13011-74370
				2	87 × 1.5 × 3.6					
				0	87 × 4 × 2.65					
1MZ	2994	●Abaron	6	1	87.5 × 1.2 × 2.8	RN	GN	SV	28033	13011-20010 13011-20012 13011-20020 13011-20022
				2	87.5 × 1.2 × 3.2					
				0	87.5 × 3 × 2.8					
2MZ	2500	●Windom	6	1	87.5 × 1.2 × 2.9			SV	28955	13011-20050
				2	87.5 × 1.2 × 3.3					
				0	87.5 × 3 × 2.7					
1UZ	4000	●Celcio ●Texas	8	1	87.5 × 1.2 × 2.8		GN	SV	28865	13011-50110
				2	87.5 × 1.2 × 3.4					
				0	87.5 × 3 × 2.7					
1UZ-FE	4000	●Celcio	8	1	87.5 × 1.5 × 3.3		GN	SV	28693	13011-50040
				2	87.5 × 1.5 × 3.8					
				0	87.5 × 3 × 2.65					
1UZ-FE-2	3968	●Celsior, ●Crown ●Majesta	8	1	87.5 × 1.5 × 3.3		GN	SV	28046	13011-50060
				2	87.5 × 1.5 × 3.6					
				0	87.5 × 3.0 × 2.65					
2VZ-FE			6	1	87.5 × 1.5 × 3.3		GN	SV	28321	13011-62040
				2	87.5 × 1.5 × 3.8					
				0	87.5 × 3 × 2.8					
3VZ	2958	●Hi-Lux ●VCV10	6	1	87.5 × 1.5 × 3.3		GN	SV	28410	13011-65020
				2	87.5 × 1.5 × 3.7					
				0	87.5 × 4 × 2.95					
3VZ	2958	●Hi-Lux ●VCV10	6	1	87.5 × 1.5 × 3.3		GN	SV	28482	13011-65021 13011-62060
				2	87.5 × 1.5 × 3.8					
				0	87.5 × 4 × 2.8					
3VZ-FE	2958	●Hi-Lux ●VCV10	6	1	87.5 × 1.5 × 3.3		GN	SV	28402	13011-62090
				2	87.5 × 1.5 × 3.8					
				0	87.5 × 4 × 2.8					
4VZ-FE	2496	●Camry ●WINDOM	6	1	87.5 × 1.5 × 3.3		GN	SV	28421	13011-62080
				2	87.5 × 1.5 × 3.8					
				0	87.5 × 3 × 2.8					
エンジン型式	排気量	車名・型式	シリン ダー数	位置	サイズ 径×中×厚さ	材質	表面改質	セットタイプ	セットNo.	備考
ピストンリング										

Engine Type	cc	Vehicle Model Chassis Type	Cyl. No.	Piston Ring						Remarks
				Position	Size (mm) d ₁ ×h ₁ ×a ₁ (D×B×T)	Material	Surface Treatment	Set Type	Set No. ※	

統 TOYOTA MOTOR CORP. トヨタ自動車(株)

○——ガソリン車 Gasoline-engine Automobiles

※(): OLD SET No.

1MZ	2994	●Camry	6	1	87.5 × 1.2 × 2.9			SV	28415	13011-20023
				2	87.5 × 1.2 × 3.2					
				0	87.5 × 3 × 2.65					
3GR-D4	3000	●Crown ●Mark X ●Lexus GS	6	1	87.5 × 1.2 × 2.7	RN	GN	SM	28082	13011-31110
				2	87.5 × 1.2 × 2.7		GN			13011-31170
				0	87.5 × 2.0 × 2.0					
3R	1877	●Crown RS30, 31, 40, 41, 46G	4	1	88 × 2.5 × 4.1			FV	28460	13011-49010
				2	88 × 2.5 × 4.1					13011-40010
				0	88 × 5 × 4.1					
5R	1994	●Crown ●Stout RS50, RS50B, RK171, RK171V-B	4	1	88 × 2 × 4.2	RN		FV	28550	13011-44061,62,63
				2	88 × 2.5 × 4.2					13011-44060
				0	88 × 4 × 4.1					13011-44010 13011-44030,40 13011-44042 13011-44043
16R 18R	1800 1968	●Corona-Mark II	4	1	88.5 × 2 × 4.2	RN		FV	28820	13011-34030,20,21,22
				2	88.5 × 2.5 × 4.2					13011-38010,20,40,60
				0	88.5 × 4 × 3.85					13011-34012, 13 13011-34050
2AZ	2362	●ESTIMA ●ALPHARD	4	1	88.5 × 1.2 × 2.7		Cr1	SV	28017	13011-28151
				2	88.5 × 1.2 × 3.2					-28101
				0	88.5 × 2 × 2.5		GN			-28102
F	3878	●Truck FA80, FA80D	6	1	90 × 3 × 3.7			FV	28610	13011-60011
				2	90 × 3 × 3.7					13011-69021
				0	90 × 4 × 4.1					
				0	90 × 4 × 3.7					
F(New)	3878	●Truck FA80, FA80D, FA90, FC80, FA90D, FA100, FA110, FJ40, 2FQ10, FJ43	6	1	90 × 2 × 4			FV	28100	13011-60040
				2	90 × 2.5 × 4					
				0	90 × 4 × 4					
				0	90 × 4 × 4					
4Y	2200	●For Leaded	4	1	91 × 1.5 × 3.3		GN	SV	28420	13011-73030
				2	91 × 1.5 × 4					13011-73020
				0	91 × 4 × 3.1					13011-73031,73032 13011-73040
4Y	2200	●For Leaded	4	1	91 × 1.5 × 3.3		Cr1	SV	28008	
				2	91 × 1.5 × 4					
				0	91 × 4 × 3.1					
22R	2366	●Coaster	4	1	92 × 2 × 4.2		Cr4	FV	28540	13011-35030
				2	92 × 2.5 × 4.2					13011-35020
				0	92 × 4 × 3.1					13011-35010
エンジン型式	排気量	車名・型式	シリン ダー数	位置	サイズ 径×中×厚さ	材質	表面改質	セットタイプ	セットNo.	備考
ピストンリング										

Engine Type	cc	Vehicle Model Chassis Type	Cyl. No.	Piston Ring						Remarks
				Position	Size (mm) d ₁ ×h ₁ ×a ₁ (D×B×T)	Material	Surface Treatment	Set Type	Set No. ※	

統 TOYOTA MOTOR CORP. トヨタ自動車(株)

○——ガソリン車 Gasoline-engine Automobiles

※(): OLD SET No.

22R-2	2400	●Cressida	4	1	92 × 1.5 × 3.3		GN	SV	28541	13011-35040
				2	92 × 1.5 × 4					13011-35050,35052
				0	92 × 4 × 3.1					13011-35060,35061
				1	92 × 1.5 × 3.3					13011-35070,35071
				2	92 × 1.5 × 4					
				0	92 × 4 × 3.1					
22R-4	2400	●Coaster RB20 ●Land Cruiser	4	1	92 × 1.5 × 3.3		GN	SV	28066	13011-35041
				2	92 × 1.5 × 4					
				0	92 × 4.0 × 3.1					
5VZ	3378	●Hi-Lux	6	1	93.5 × 1.5 × 3.3		GN	SV	28305	13011-62110
				2	93.5 × 1.5 × 4					13011-62120
				0	93.5 × 4 × 2.85					13011-62100
2F	4230	●Truck FJ55, FA101, FC22D	6	1	94 × 2 × 4.2		Cr4	FV	28090	13011-61010
				2	94 × 2.5 × 4.2					
				0	94 × 4 × 3.9					
3F	4000	●Land Cruiser	6	1	94 × 1.5 × 3.6		GN	SV	28140	13011-61060
				2	94 × 1.5 × 4					13011-61061
				0	94 × 4 × 3.4					
				1	94 × 1.5 × 3.6					
				2	94 × 1.5 × 4					
				0	94 × 4 × 3.4					
3F(New)	4000	●Land Cruiser	6	1	94 × 2 × 3.35		Cr1	SV	28060 (44501)	13011-61062
				2	94 × 2 × 4					
				0	94 × 4 × 3.4					
1GR-FE	3955	●Crown ●Mark II	6	1	94 × 1.2 × 3.25		Cr1	SV	28059	13011-31100
				2	94 × 1.2 × 3.4					
				0	94 × 2.0 × 2.8					
2GR-FE	3500	●Harrier ●Camry ●Rav4 ●Avalon ●Lexus ES,RX	6	1	94 × 1.2 × 2.9	RN	GN	SV	28073	13011-31130
				2	94 × 1.2 × 2.9					13011-31140
				0	94 × 2.0 × 2.8					13011-31150
2UZ-FE			8	1	94 × 1.5 × 3.3		GN	SV	28905	13011-50150
				2	94 × 1.5 × 4					
				0	94 × 4 × 2.65					
2TR	2700	●Hi-Lux Surf ●Hi Ace ●Land Cruiser Prado	4	1	95 × 1.2 × 2.9		GN	SM	28041	13011-75110
				2	95 × 1.2 × 3.4					13011-75130
				0	95 × 2.0 × 2.0					13011-OC030
2TZ-FE	2400		4	1	95 × 1.75 × 3.65			SV	28653	13011-76050
				2	95 × 1.5 × 3.8					13011-76010
				0	95 × 4 × 3.1					
2RZ	2438	●Hi-Ace ●RZH101G	4	1	95 × 1.75 × 3.5	RN	GN	SV	28185 (28945)	13011-75030
				2	95 × 1.5 × 3.8					
				0	95 × 4 × 3.15					
エンジン型式	排気量	車名・型式	シリンダー数	位置	サイズ 径×中×厚さ	材質	表面改質	セットタイプ	セットNo.	備考
ピストンリング										

TOYOTA MOTOR CORP.
トヨタ自動車(株)

Engine Type	cc	Vehicle Model Chassis Type	Cyl. No.	Piston Ring						Remarks
				Position	Size (mm) d ₁ ×h ₁ ×a ₁ (D×B×T)	Material	Surface Treatment	Set Type	Set No. [※]	

統 TOYOTA MOTOR CORP. トヨタ自動車(株)

○——ガソリン車 Gasoline-engine Automobiles

※ (): OLD SET No.

2RZ-FE	2438	●Hi-Ace ●RZH101G	4	1	95 × 1.5 × 3.5		GN	SV	28313	13011-75040
				2	95 × 1.5 × 3.6					
				0	95 × 4 × 2.95					
3RZ-FE	2693	●Hi-Lux ●Granbia ●Dyna	4	1	95 × 1.75 × 3.5		GN	SV	28315	13011-75060
				2	95 × 1.5 × 3.6					
				0	95 × 4 × 2.95					
1FZ	4476	●Land Cruiser ●FZJ80G	6	1	100 × 1.75 × 3.8		GN	SV	28484	13011-66021
				2	100 × 2 × 3.8					
				0	100 × 4 × 3.15					
1FZ	4476	●Land Cruiser ●FZJ80G	6	1	100 × 2 × 3.6		GN	SV	28021	13011-66020
				2	100 × 2 × 3.8					
				0	100 × 4 × 3.15					
1FZ	4476	●Land Cruiser ●FZJ80G	6	1	100 × 1.75 × 3.8		GN	SV	28078	13011-66021
				2	100 × 2.0 × 3.8					
				0	100 × 4.0 × 3.1					
エンジン型式	排気量	車名・型式	シリンダー数	位置	サイズ 径×巾×厚さ	材質	表面改質	セットタイプ	セットNo.	備考
ピストンリング										

Engine Type	cc	Vehicle Model Chassis Type	Cyl. No.	Piston Ring						Remarks
				Position	Size (mm) d ₁ ×h ₁ ×a ₁ (D×B×T)	Material	Surface Treatment	Set Type	Set No. ※	

統 TOYOTA MOTOR CORP. トヨタ自動車(株)

○—ディーゼル車 Diesel-engine Automobiles

※ (): OLD SET No.

1ND-FTV	1400	●Yaris	4	1	73 × 1.5 × 2.3	RN	GN	SM	28084	13011-33051
				2	73 × 1.2 × 2.6		Cr1			
				0	73 × 2.0 × 2.0		GN			
1CD	1995	●Corolla ●Avencis	4	1	82.2 × 2.0 × 2.8		GN	SM	28069	13011-27030
				2	82.2 × 1.5 × 2.55		GN			
				0	82.2 × 3.0 × 2.0		GN			
1CDDA	2000	●Corolla	4	1	82.2 × 2.0 × 2.7	RN	Cr1	FM	28072	13011-27040
				2	82.2 × 1.5 × 2.65		GN			
				0	82.2 × 3.0 × 2.0					
1C, 1CL	1839	●Corona ●Carina ●Carolla ●Sprinter	4	1	83 × 2 × 3.7	RN	Cr4	FX	28120	13011-64020,10
				2	83 × 2 × 3.7		13011-64040			
				0	83 × 4 × 2.7		13011-64070 13011-64080 IST=HALF KEYSTONE			
1C	1839	●Corona ●Carina ●Carolla	4	1	83 × 2 × 3.1		GN	SV	28755	13011-64130
				2	83 × 2 × 3.6		13011-64220			
				0	83 × 3 × 2.8		GN IST=HALF KEYSTONE			
2C	1974	●Carolla ●Master Ace CE100, CT141, CV30, CHR11G	4	1	86 × 1.75 × 3.1		GN	SM	28026	13011-64170
				2	86 × 2 × 3.5					IST=HALF KEYSTONE
				0	86 × 3 × 2					
2C	1974	●Carolla ●Master Ace CE100, CT141, CV30, CHR11G	4	1	86 × 2 × 3.3		GN	SX	28275	13011-64060
				2	86 × 2 × 3.9		13011-64110			
				0	86 × 4 × 2.5		RN 13011-64150 IST=HALF KEYSTONE			
2C(New)	1974	●Carolla ●Master Ace CE100, CT141, CV30, CHR11G	4	1	86 × 2 × 3.3		GN	SM	28029	13011-64190
				2	86 × 2 × 3.5					IST=HALF KEYSTONE
				0	86 × 3 × 2					
2C	2000	●Carina ●Tamaraw FX	4	1	86 × 2 × 3.3	RN	GN	SM	28245	13011-64202
				2	86 × 2 × 3.4		IST=HALF KEYSTONE			
				0	86 × 3 × 2		GN			
2C-T, 3C-T	2000	●Carina ●Estima ●Emina ●Tamaraw Fix	4	1	86 × 1.968 × 3.1		GN	SM	28034	13011-64212
				2	86 × 2 × 3.2		13011-64213			
				0	86 × 3 × 2		GN IST=HALF KEYSTONE			
2C-T-2 3C-T	1974 2200	●Carina ●Master Ace ●Town-Ace ●Lite-Ace	4	1	86 × 2.0 × 3.1		GN	SM	28053	13011-64210
				2	86 × 2.0 × 3.05		13011-64230			
				0	86 × 3.0 × 2.0		GN IST=HALF KEYSTONE			
1DZ, 3C-T	2184	●Estima, Lucina ●Emina CXR11G	4	1	86 × 2 × 3.1		GN	SM	28993	13011-78201
				2	86 × 2 × 3.6		IST=HALF KEYSTONE			
				0	86 × 4 × 2.5		GN			
1DZ	2184	●Estima	4	1	86 × 1.968 × 3.1	RN	GN	SM	28064	13011-78200-71
				2	86 × 1.942 × 3.5		GN			
				0	86 × 4.0 × 2.5		GN IST=HALF KEYSTONE			
エンジン型式	排気量	車名・型式	シリン ダ―数	位置	サイズ 径×巾×厚さ	材質	表面改質	セットタイプ	セットNo.	備考
ピストンリング										

TOYOTA MOTOR CORP.
トヨタ自動車(株)

Engine Type	cc	Vehicle Model Chassis Type	Cyl. No.	Piston Ring						Remarks
				Position	Size (mm) d ₁ ×h ₁ ×a ₁ (D×B×T)	Material	Surface Treatment	Set Type	Set No. ※	

統 TOYOTA MOTOR CORP. トヨタ自動車(株)

○ ——— ディーゼル車 Diesel-engine Automobiles

※ (): OLD SET No.

2DZ	2184	●Estima	4	1	86 × 2.0 × 3.1		GN	SM	28051	13011-78201-71
				2	86 × 2.0 × 3.05					
				0	86 × 4.0 × 2.5					
1,2DZ	2184	●Forklift	4	1	86 × 1.968 × 3.1		GN	SM	28063	13011-78202-71
				2	86 × 2.0 × 3.05					
				0	86 × 3.0 × 2.0					
J 2J	2336 2481	●Dyna JK170B, JK171B, JK170DH, JK175, JK171DH, JK176, JK176V	4	1	88 × 2.5 × 3.8		Cr4	FO	28530	13011-46021
				2	88 × 2.5 × 3.8					
				3	88 × 2.5 × 3.8					
				0	88 × 4 × 3.8					
				0	88 × 4 × 3.8					
2J(New)	2481	●Dyna	4	1	88 × 2.5 × 3.8	RN		FX	28770	13011-48021
				2	88 × 2.5 × 3.8					13011-48013
				3	88 × 2.5 × 3.8					
				0	88 × 4 × 4					IST=KEYSTONE
2J(New)	2481	●Dyna	4	1	88 × 2.5 × 3.8	RN		FX	28780	13011-48023
				2	88 × 2.5 × 3.8					13011-48022
				0	88 × 4 × 2.9					13011-48030
H	3576	●Dyna H-Mobit	6	1	88 × 2.5 × 3.8		Cr4	FO	28641	13011-47020
				2	88 × 2.5 × 3.8					
				3	88 × 2.5 × 3.8					
				0	88 × 4 × 3.8					
				0	88 × 4 × 3.8					
H(New)	3576	●Dyna	6	1	88 × 2.5 × 3.8	RN		FX	28310	13011-47021
				2	88 × 2.5 × 3.8					
				3	88 × 2.5 × 3.8					
				0	88 × 4 × 2.9					
H(New,New)	3576	●Dyna	6	1	88 × 2.5 × 3.8	RN	Cr4	FX	28320	13011-47023
				2	88 × 2.5 × 3.8					13011-47022
				0	88 × 4 × 2.9					IST=HALF KEYSTONE
20R	2189	●Coaster	4	1	88.5 × 2 × 4.2		Cr4	FX	28150	13011-38030
				2	88.5 × 2.5 × 4.2					
				0	88.5 × 4 × 4					
				0	88.5 × 4 × 4					
L	2188	●Crown ●Chaser ●Mark II ●Hi-Ace Wagon ●Brizzard ●Coaster ●Toyoace ●Hi-Luxe ●Quick Delivery	4	1	90 × 2.5 × 3.8	RN	Cr4	FX	28850	13011-54021
				2	90 × 2 × 3.9					13011-54020
				0	90 × 4 × 3					13011-54010
エンジン型式	排気量	車名・型式	シリン ダー数	位置	サイズ 径×中×厚さ	材質	表面改質	セットタイプ	セットNo.	備考
ピストンリング										

Engine Type	cc	Vehicle Model Chassis Type	Cyl. No.	Piston Ring						Remarks
				Position	Size (mm) d ₁ ×h ₁ ×a ₁ (D×B×T)	Material	Surface Treatment	Set Type	Set No. ※	

統 TOYOTA MOTOR CORP. トヨタ自動車(株)

○——ディーゼル車 Diesel-engine Automobiles

※(): OLD SET No.

L(New)	2188	●Crown ●Chaser ●Mark II ●Hi-Ace ●Brizzard ●Coaster ●Toyoace ●Hi-Luxe ●Quick Delivery	4	1	90 × 2 × 3.8	RN	Cr4	FX	28860	13011-54040
				2	90 × 2 × 3.9					13011-54041
				0	90 × 4 × 3					13011-54042 13011-54030,31,32
2L	2400	●Toyoace, Hi-Luxe ●Brizzard LS130V, LX80, LJ71G, LX90, LX130	4	1	90 × 2 × 3.4	RN		FX	28280	13011-54080
				2	90 × 2 × 3.9					IST=HALF KEYSTONE
				0	90 × 4 × 3					
2H	3980	●Land Cruiser ●Coaster	6	1	91 × 2.52 × 4	RN		FX	28680	13011-96601
				2	91 × 2.52 × 4					13011-68010
				0	91 × 4 × 3.1					13011-68020 IST=HALF KEYSTONE
12H-T	3980	●Bus ●Coaster	6	1	91 × 2.5 × 3.5		GN	SX	28975	13011-68030
				2	91 × 2.5 × 4					IST=HALF KEYSTONE
				0	91 × 4 × 3.1					
DR100 DQ100	4507	●Truck	6	1	92 × 2.5 × 3.9			FO	28650	13011-66010
				2	92 × 2.5 × 3.9					
				3	92 × 2.5 × 3.9					
				0	92 × 4 × 3.9					
				0	92 × 4 × 3.9					
2L-T,2L-TE	2446	●Crown ●Chaser ●Corona Mark II	4	1	92 × 2 × 3.6			SX	28740	13011-54090
				2	92 × 2 × 4					13011-54060
				0	92 × 4 × 3.3					13011-54050 13011-54061,54062 13011-54100 IST=HALF KEYSTONE
2L-T		●Chaser ●Crown ●Corona Mark II ●Dyna	4	1	92 × 2 × 3.3		GN	SM	28741	13011-54100
				2	92 × 2 × 3.55					IST=HALF KEYSTONE
				0	92 × 4 × 2.5					
2KD		●Hi-Lux	4	1	92 × 2 × 2.8	RN	GN	SM	28080	13011-30030
				2	92 × 1.5 × 2.9					13011-30031
				0	92 × 3 × 2					13011-30060
1H,1HZ	3576	●Land Cruiser HZJ81V, HDJ81V	6	1	94 × 2 × 3.6			SX	28005	13011-17010,17011
				2	94 × 2 × 4					13011-17020,17030
				0	94 × 4 × 2.7					IST=HALF KEYSTONE
1HD-FTE	4200	●Land Cruiser	6	1	94 × 2.0 × 3.3	RN	GN	SM	28079	13011-17040
				2	94 × 1.5 × 3.3					
				0	94 × 4.0 × 2.5					
1PZ	3500	●Land Cruiser ('90 ~ '94)	5	1	94 × 2 × 3.6		GN	SM	28643	13011-18010
				2	94 × 2 × 4					13011-18030
				0	94 × 4 × 2.5					IST=HALF KEYSTONE
エンジン型式	排気量	車名・型式	シリン ダー数	位置	サイズ 径×巾×厚さ	材質	表面改質	セットタイプ	セットNo.	備考
ピストンリング										

Engine Type	cc	Vehicle Model Chassis Type	Cyl. No.	Piston Ring						Remarks
				Position	Size (mm) d ₁ ×h ₁ ×a ₁ (D×B×T)	Material	Surface Treatment	Set Type	Set No. ※	

統 TOYOTA MOTOR CORP. トヨタ自動車(株)

○——ディーゼル車 Diesel-engine Automobiles

※(): OLD SET No.

B	2977	●Dyna Bu10, 12, 15, 20, 30	4	1	95 × 2.5 × 4.2		Cr4	FX	28830	13011-56010
				2	95 × 2.5 × 4.2					
				3	95 × 2.5 × 4.2					
				0	95 × 4.5 × 3.3					
B(New)	2977	●Dyna	4	1	95 × 2.5 × 3.9	RN		FX	28110	13011-56011
				2	95 × 2.5 × 4.3					
				3	95 × 2.5 × 4.3					
				0	95 × 4.5 × 3.3					
B(New,New)	2977	●Dyna ●Toyoace	4	1	95 × 2.5 × 4.1	RN	Cr4	FX	28910	13011-56021,56022 13011-56013 13011-56012 IST=HALF KEYSTONE
				2	95 × 2.5 × 4.3					
				0	95 × 4.5 × 3.4					
10B 11B B(NEW,NEW)	2977		4	1	95 × 2.5 × 3.6	RN		FX	28715	13011-56040
				2	95 × 2 × 4.2					
				0	95 × 4 × 2.4					
11B	2977	●Dyna ●Toyoace	4	1	95 × 2.5 × 3.6		GN	SM	28855	13011-56041
				2	95 × 2.0 × 4.2					
				0	95 × 4.0 × 3.4					
11B	2977	●Dyna ●Toyoace	4	1	95 × 2.5 × 3.8		GN	SX	28083	13011-56030
				2	95 × 2.5 × 4.3					
				0	95 × 4.5 × 3.4					
11B	2977		4	1	95 × 2.5 × 3.7		Cr4	FX	28076	13011-56030
				2	95 × 2.5 × 4.3					
				0	95 × 4.5 × 2.7					
1Z	2977	●Dyna	4	1	96 × 2 × 3.6			SX	28545	13011-78300
				2	96 × 2 × 4.3					
				0	96 × 4 × 3					
1Z	2977	●Dyna	4	1	96 × 2.0 × 3.3		GN	SX	28048	13011-78300-71
				2	96 × 2.0 × 4.4					
				0	96 × 4.0 × 3.0					
3L	2779	●Toyoace ●Hi-Luxe ●Hi-Ace Van LY51	4	1	96 × 2 × 3.3			SX	28006	13011-54120
				2	96 × 2 × 4.2					
				0	96 × 4 × 2.7					
1KZ-T 1KZ-TE	2982	●Hi-Ace ●Land Cruiser ●Hi-lux Surf	4	1	96 × 1.94 × 3.3		GN	SM	28773	13011-67030
				2	96 × 2 × 3.4					
				0	96 × 3 × 2					
1KD	2982	●Hi-Ace ●PRADO	4	1	96 × 2 × 3.35		GN	SM	28036	13011-30040 13011-30020 -30021 -30022 -30050,30051
				2	96 × 1.5 × 3.25					
				0	96 × 3 × 3					
2B	3186	●Land Cruiser	4	1	98 × 2.526 × 4.1	RN	Cr4	FX	28180	13011-57010
				2	98 × 2.5 × 4.3					
				0	98 × 4.5 × 3.4					
エンジン型式	排気量	車名・型式	シリン ダー数	位置	サイズ 径×中×厚さ	材質	表面改質	セットタイプ	セットNo.	備考
ピストンリング										

Engine Type	cc	Vehicle Model Chassis Type	Cyl. No.	Piston Ring						Remarks
				Position	Size (mm) d ₁ ×h ₁ ×a ₁ (D×B×T)	Material	Surface Treatment	Set Type	Set No. ※	

統 TOYOTA MOTOR CORP. トヨタ自動車(株)

○—ディーゼル車 Diesel-engine Automobiles

※(): OLD SET No.

2Z 13Z			4	1	98 × 2 × 3.6		GN	SM	28065	13011-78701-71 13011-78760-71				
				2	98 × 2 × 3.55									
				0	98 × 4 × 2.5									
2Z	3469	●Forklift	4	1	98 × 2.0 × 3.6		GN	SM	28049	13011-78700-71				
				2	98 × 2.0 × 4.2									
				0	98 × 4.0 × 2.5									
5L	3000	●Hi-Ace	4	1	99.5 × 2 × 3.6		GN	SM	28553	13011-54130				
				2	99.5 × 1.5 × 3.7									
				0	99.5 × 4.4 × 4									
D	5890	●DA100, DA100D, DC80C	6	1	100 × 3 × 4			FO	28700	13011-79011 13011-76010				
				2	100 × 3 × 4									
				3	100 × 3 × 4									
				0	100 × 4 × 4									
				0	100 × 4 × 4									
1D	5890		6	1	100 × 3 × 4		Cr4	FO	28096	13011-76012				
				2	100 × 3 × 4									
				3	100 × 3 × 4									
				0	100 × 4 × 4									
				0	100 × 4 × 4									
3B	3431	●Land Cruiser ●Dyna Coaster	4	1	102 × 2.55 × 4.3	RN	Cr4	FX	28880	13011-58010 IST=HALF KEYSTONE				
				2	102 × 2.5 × 4.3									
				0	102 × 4.5 × 3.4									
13B	3400	●Dyna Coaster	4	1	102 × 2.5 × 4.1	RN		FX	28881	13011-58030				
				2	102 × 2.5 × 4.3									
				0	102 × 4.5 × 2.8									
13BT	3431	●Toyoace BUS ●Dyna BUS	4	1	102 × 2.5 × 4.1	RN		FX	28815	13011-58040 IST=HALF KEYSTONE				
				2	102 × 2.5 × 4.3									
				0	102 × 4.5 × 2.8									
3BK	3431	●Dyna Coaster ●Land Cruiser BJ60 ●DAIHATSU Delta ●HINO Ranger HV48	4	1	102 × 2.54 × 4.1	RN	Cr4	FX	28075	13011-58011 IST=KEYSTONE				
				2	102 × 2.5 × 4.3									
				0	102 × 4.5 × 2.6									
13B(New) 14B	3400 3700	●Dyna Coaster	4	1	102 × 2.5 × 3.8	RN		SX	28882	13011-58050 13011-58051 IST=HALF KEYSTONE				
				2	102 × 2 × 4.3									
				0	102 × 4 × 2.5									
				1	102 × 2.5 × 3.8						RN	FX	28475	IST=HALF KEYSTONE
				2	102 × 2 × 4.3									
0	102 × 4 × 2.5													
14BT	3660	●Dyna Coaster	4	1	102 × 3 × 3.8		GN	SM	28575	13011-58060 IST=HALF KEYSTONE				
				2	102 × 2 × 4.3									
				0	102 × 4 × 2.35									
14B	3660	●Dyna Coaster	4	1	102 × 2.5 × 3.8		GN	SM	28037	13011-58070 13011-58072 IST=HALF KEYSTONE				
				2	102 × 2 × 4.3									
				0	102 × 4 × 2.35									

エンジン型式	排気量	車名・型式	シリン ダー数	位置	サイズ 径×中×厚さ	材質	表面改質	セットタイプ	セットNo.	備考
--------	-----	-------	------------	----	------------	----	------	--------	--------	----

Engine Type	cc	Vehicle Model Chassis Type	Cyl. No.	Piston Ring						Remarks
				Position	Size (mm) d ₁ ×h ₁ ×a ₁ (D×B×T)	Material	Surface Treatment	Set Type	Set No. ※	

統 TOYOTA MOTOR CORP. トヨタ自動車(株)

○—ディーゼル車 Diesel-engine Automobiles

※(): OLD SET No.

14B 3B	3660	●Dyna300	4	1	102 × 2.5 × 3.8		GN	SM	28077	13011-58050
				2	102 × 2.0 × 4.3		Cr1			13011-58051
				0	102 × 4.0 × 2.5		GN			IST=HALF KEYSTONE
1W			4	1	104 × 2.5 × 4.3	RN	Cr4	FX	28781	13011-78010
				2	104 × 2 × 4.3					
				0	104 × 5 × 3.2					
2D	6494	●DA90, DB90, DA90D, DB92, DA95, DB102, DA110, DR11, DA115D, DB100C	6	1	105 × 3 × 4.2	RN	Cr4	FX	28710	13011-77022
				2	105 × 3 × 4.2					13011-77023
				3	105 × 3 × 4.2					13011-77010
				0	105 × 5 × 3.2					13011-77020
				0	105 × 5 × 4.2					13011-77021
2D	6494	●DA90, DB90, DA90D, DB92, DA95, DB102, DA110, DR11, DA115D, DB100C	6	1	105 × 3 × 4.2		Cr4	FX	28300	13011-77024
				2	105 × 3 × 4.2					
				3	105 × 3 × 4.2					
				0	105 × 5 × 3.4					
2D	6494	●Truck	6	1	105 × 3 × 4	RN	Cr4	FX	28160	13011-77040
				2	105 × 2.5 × 4.5					13011-77041
				3	105 × 2.5 × 4.5					13011-77050
				0	105 × 5 × 3.5					IST=HALF KEYSTONE
15B-F	4104	●Mega Cruiser	4	1	108 × 3 × 4.1		GN	SM	28004	13011-58090
				2	108 × 2 × 4.3					
				0	108 × 4 × 2.5		GN			IST=HALF KEYSTONE
15B-FTE	4100	●Mega Cruiser ●Toyo-Ace ●Dyna	4	1	108 × 3.0 × 3.8		GN	SM	28068	13011-58110
				2	108 × 2.0 × 3.9	RN	Cr1			
				0	108 × 4.0 × 2.5		GN			
エンジン型式	排気量	車名・型式	シリン ダー数	位置	サイズ 径×巾×厚さ	材質	表面改質	セットタイプ	セットNo.	備考
ピストンリング										

Engine Type	cc	Vehicle Model Chassis Type	Cyl. No.	Piston Ring						Remarks
				Position	Size (mm) d ₁ ×h ₁ ×a ₁ (D×B×T)	Material	Surface Treatment	Set Type	Set No. ※	

●MAZDA MOTOR CORP. マツダ(株)

○—ガソリン車 Gasoline-engine Automobiles

※(): OLD SET No.

	800	●Familia 800	4	1 2 0	58 × 1.5 × 2.7 58 × 1.5 × 2.7 58 × 4 × 2.2	RN		FE	30430	0187-23-999
PB	987	●Familia 1000 SPB, SPA, BPAV, BPAVO, PPBKV ●Truck FPA, FPAV, EPAH, H-FPA, H-FPAV	4	1 2 0	68 × 2 × 3 68 × 2 × 3 68 × 4 × 2.425	RN		FV	30530	0249-23-170A 0249-23-206 0259-23-170A 0259-23-206
B1	987	●Truck	4	1 2 0	68 × 1.2 × 2.6 68 × 1.5 × 2.9 68 × 3 × 2.8		GN	SV	30170	B1Y1-11-SCOA B1Y0-11-SCO
E1	1100	●Familia ●Truck	4	1 2 0	70 × 1.5 × 2.8 70 × 2 × 3.1 70 × 4 × 3.2		RF	SV	30950	E103-23-130C
E1	1100	●Familia ●Truck	4	1 2 0	70 × 1.2 × 3.15 70 × 1.5 × 3.1 70 × 4 × 3.2			SV	30020	E101-23-130A
E1	1100		4	1 2 0	70 × 1.2 × 3.15 70 × 1.5 × 3.1 70 × 4 × 3.2			SV	30110	E101-23-130
TA	1100	●D1100	4	1 2 0	70 × 2.5 × 3.1 70 × 2.5 × 3.1 70 × 4 × 3.1			FO	30440	0106-11-999
PA	985	●Familia-Coupe	4	1 2 0	70 × 2 × 3.1 70 × 2 × 3.1 70 × 4 × 2.5	RN		FE	30480	0221-23-999 0271-23-206
TB	1139	●Familia 1000 STA, BTA65, BTAV, BTA55	4	1 2 0	70 × 2 × 3.1 70 × 2 × 3.1 70 × 4 × 2.5	RN		FV	30560	0268-23-170A
PC TB	985 1139	●Prest 1200 ●Familia 1000, 1200 STA, BTA65, BTAV, BTA55, SPC, SPCV, FA3PS, A-FA3PS	4	1 2 0	70 × 2 × 3.1 70 × 2 × 3.1 70 × 4 × 2.5	RN		FV	30600	0317-23-175 0317-23-130
PC	985	●Familia	4	1 2 0	70 × 1.5 × 3.1 70 × 1.5 × 3.1 70 × 4 × 3.1	RN		FV	30040	8698-23-130
B3	1300	●BG3S	4	1 2 0 1 2 0	71 × 1.2 × 2.6 71 × 1.5 × 2.9 71 × 3 × 2.8 71 × 1.2 × 2.6 71 × 1.5 × 2.9 71 × 3 × 2.8		GN GN Cr1	SV SV	30150 30142	B3Y1-11-SC0A B3Y0-11-SC0A
エンジン型式	排気量	車名・型式	シリン ダー数	位置	サイズ 径×中×厚さ	材質	表面改質	セットタイプ	セットNo.	備考
ピストンリング										

Engine Type	cc	Vehicle Model Chassis Type	Cyl. No.	Piston Ring						Remarks
				Position	Size (mm) d ₁ ×h ₁ ×a ₁ (D×B×T)	Material	Surface Treatment	Set Type	Set No. ※	

統 MAZDA MOTOR CORP. マツダ (株)

○ — ガソリン車 Gasoline-engine Automobiles

※ (): OLD SET No.

TC(New)	1272	●Familia	4	1	73 × 1.5 × 3.1	RN	Cr4	FV	30770	8034-23-130A	
				2	73 × 1.5 × 3.1						
				0	73 × 4 × 3.1						
TC	1272	●Familia 1300 STB, STBU, STC, FA3TS, FA2T55, 65, BS7C, HSTBU,HSTCV, HFA2T55, 65 ●Truck BTA67	4	1	73 × 2 × 3.1	RN		FV	30590	0324-23-130 0324-23-175	
				2	73 × 2 × 3.1						
				0	73 × 4 × 2.5						
JF		●Truck	6	1	74 × 1.5 × 3.1			SV	30610	JFY1-11-SCO	
UA	1484	●Craft 1500	4	1	75 × 2.5 × 3.3			FV	30490	0603-23-170 0603-23-999	
				2	75 × 2.5 × 3.3						
				0	75 × 4 × 2.8						
DUC,UA(New)	1484	●New Craft	4	1	75 × 2 × 3.3	RN		FV	30690	0571-23-170 0571-23-180	
				2	75 × 2 × 3.3						
				0	75 × 4 × 3.1						
Z5D	1489	●Protege	4	1	75.3 × 1 × 2.8			SV	30990	Z5Z0-11-SCO	
				2	75.3 × 1.2 × 3.2						
				0	75.3 × 2.5 × 2.5						
Z5		●Protege	4	1	75.3 × 1 × 2.8		Cr4	SV	30001	Z5Y0-11-SCO	
				2	75.3 × 1.2 × 3.2						
				0	75.3 × 2.5 × 2.5						
E3	1296		4	1	77 × 1.2 × 3.35			Cr4	SV	30030	E301-23-130A
				2	77 × 1.5 × 3.2						
				0	77 × 4 × 3.2						
E3	1296		4	1	77 × 1.5 × 3.1			GN	SV	30245	E302-23-130A
				2	77 × 2 × 3.3						
				0	77 × 4 × 3.2						
E3, E5	1490	●Familia RF5V	4	1	77 × 1.2 × 3.35			Cr4	SV	30025	E301-23-130
				2	77 × 1.5 × 3.2						
				0	77 × 4 × 3.2						
E5	1500	●Familia RF5V	4	1	77 × 1.2 × 3.1			RF	SV	30210	E512-23-130
				2	77 × 1.5 × 3.2						
				0	77 × 4 × 3.2						
E5	1500	●Familia RF5V	4	1	77 × 1.2 × 3.1			Cr1	SV	30605	
				2	77 × 1.5 × 3.2						
				0	77 × 4 × 3.2						
エンジン型式	排気量	車名・型式	シリン ダー数	位置	サイズ 径×中×厚さ	材質	表面改質	セットタイプ	セットNo.	備考	
ピストンリング											

Engine Type	cc	Vehicle Model Chassis Type	Cyl. No.	Piston Ring						Remarks
				Position	Size (mm) d ₁ ×h ₁ ×a ₁ (D×B×T)	Material	Surface Treatment	Set Type	Set No. ※	

統MAZDA MOTOR CORP. マツダ(株)

○—ガソリン車 Gasoline-engine Automobiles

※(): OLD SET No.

UC	1415	●Familia (323, GLC)	4	1	77 × 1.5 × 3.2	RN	Cr4	FV	30760	8569-23-130A	
				2	77 × 1.5 × 3.2						
				0	77 × 4 × 3.2						
E5	1490	●Familia RF5V	4	1	77 × 1.5 × 3.1			RF	30015	E302-23-130A	
				2	77 × 2 × 3.3						
				0	77 × 4 × 3.2						
NA(New)	1796	●Luce 1800	4	1	78 × 1.2 × 3.35			Cr4	30820	8170-23-130A 8658-23-130	
				2	78 × 1.5 × 3.6						
				0	78 × 4 × 3.7						
NA, VB	1796	●Luce 1800	4	1	78 × 1.5 × 3.6	RN		FV	30570	0494-23-130 0290-23-130, 131 0305-23-130 0484-23-130	
				2	78 × 1.5 × 3.6						
				0	78 × 4 × 3.6						
B6	1600	●Capela B G 6 R , N A 6 C E , GV6V	4	1	78 × 1.5 × 3.1			GN	30845	B6Y0-11-SC0	
				2	78 × 1.5 × 3.4						
				0	78 × 4 × 3.1		GN				
VB	1769	●Familia 1600 S N 3 A , S N 4 A , SN3AV, B-SN4A, H-SN3AV ●Capela SNA, B-SNA ●Truck BNA61, H-BN61	4	1	78 × 1.5 × 3.6	RN		FV	30100	3763-23-130 0222-23-206 0222-23-130	
				2	78 × 1.5 × 3.6						
				0	78 × 4 × 3.6						
NA	1586	●Luce	4	1	78 × 1.5 × 3.3			Cr4	SV	30920	H617-23-130
B62A	1600	●Capela B G 6 R , N A 6 C E , GV6V	4	1	78 × 1.5 × 3.1			Cr1	30865	B6Y3-11-SC0	
				2	78 × 1.5 × 3.4						
				0	78 × 3 × 3.1						
ZL			4	1	78 × 1.2 × 2.8				SV	30002	ZLY0-11-SCO
				2	78 × 1.5 × 3.2						
				0	78 × 3 × 3.1						
エンジン型式	排気量	車名・型式	シリン ダ数	位置	サイズ 径×中×厚さ	材質	表面改質	セットタイプ	セットNo.	備考	
ピストンリング											

MAZDA MOTOR CORP.
マツダ(株)

Engine Type	cc	Vehicle Model Chassis Type	Cyl. No.	Piston Ring						Remarks
				Position	Size (mm) d ₁ ×h ₁ ×a ₁ (D×B×T)	Material	Surface Treatment	Set Type	Set No. ※	

統 MAZDA MOTOR CORP. マツダ(株)

○—ガソリン車 Gasoline-engine Automobiles

※(): OLD SET No.

ZYV	1500	●Axela ●Demio	4	1	78 × 1.2 × 2.5			SV	30090	ZYY1-11-SC0 ZYY2-11-SC0				
				2	78 × 1.2 × 3.2									
				0	78 × 2.5 × 2.2									
ZM	1500	●Familia	4	1	78 × 1.2 × 2.8		GN	SV	30003	ZMYO-11-SCO				
				2	78 × 1.5 × 3.2									
				0	78 × 3 × 3.1									
MA(New) VC(New)	2000	●Cosmo 2000 LA2VS, 2VV, 3VS, C-LA30S, 2VV	4	1	80 × 1.2 × 3.65		Cr4	SV	30830	8682-23-130A HE18-23-130				
				2	80 × 1.5 × 3.6									
				0	80 × 4 × 3.7									
				1	80 × 1.2 × 3.65							SV	30200	8682-23-130
				2	80 × 1.5 × 3.6									
				0	80 × 4 × 3.7									
VC,MA	2000	●Luce LA2VS, 2VV, 3VS, C-LA30S, 2VV ●Cosmo C-CD2VC	4	1	80 × 2 × 3.6	RN		FV	30320	3975-23-130 0453-23-130				
				2	80 × 2 × 3.7									
				0	80 × 4 × 3.6									
MA	1970	●Cosmo ●Luce	4	1	80 × 1.5 × 3.35		Cr4	SV	30900	HE05-23-130				
				2	80 × 2 × 3.7									
				0	80 × 4 × 3.2									
F6	1587	●Capela	4	1	81 × 1.5 × 3.3		RF	SV	30650	F601-23-130				
				2	81 × 1.5 × 3.6									
				0	81 × 4 × 3.2									
				1	81 × 1.5 × 3.3							Cr1	SV	30655
				2	81 × 1.5 × 3.6									
				0	81 × 4 × 3.2									
EVB, VA	1985	●G2000	4	1	82 × 2 × 3.6	RN		FV	30520	0552-23-180 0552-23-190 1352-23-130				
				2	82 × 2 × 3.6									
				0	82 × 4.5 × 3.6									
VA	1985	●Truck LE2000, EVA12, 12D, 12P,32S,EVB12, 12D, 43S, 13S ●Three-wheeled Vehicles TVA12, 32S, 82, 82A, AEVA, AEVA, B, TVADA, TVADB	4	1	82 × 2.5 × 3.6			FV	30460	0164-11-999				
				2	82 × 2.5 × 3.6									
				0	82 × 4.5 × 3.6									
BP	1800	●Familia BG8Z, BG8P	4	1	83 × 1.5 × 3.3		Cr1	SV	30275	BPY1-11-SCO				
				2	83 × 1.5 × 3.6									
				0	83 × 3 × 3.1									
323(BPD)	1800	●Lantis	4	1	83 × 1.5 × 3.3		GN	SV	30043	BPY4-11-SCO BPY4-11-SDO				
				2	83 × 1.5 × 3.6									
				0	83 × 3 × 3.1									
FPD, FSD	1800	●Familia	4	1	83 × 1.2 × 3.1			SV	30273	FSY2-11-SCO				
				2	83 × 1.5 × 3.6									
				0	83 × 3 × 3.1									
エンジン型式	排気量	車名・型式	シリン ダー数	位置	サイズ 径×中×厚さ	材質	表面改質	セットタイプ	セットNo.	備考				
ピストンリング														

Engine Type	cc	Vehicle Model Chassis Type	Cyl. No.	Piston Ring						Remarks
				Position	Size (mm) d ₁ ×h ₁ ×a ₁ (D×B×T)	Material	Surface Treatment	Set Type	Set No. ※	

統 MAZDA MOTOR CORP. マツダ(株)

○—ガソリン車 Gasoline-engine Automobiles

※(): OLD SET No.

KLD	2507	●MX6 626	4	1	84.5 × 1.5 × 3.1			SV	30982	KLY2-11-SC0 KLY1-11-SC0
				2	84.5 × 1.5 × 3.6					
				0	84.5 × 3 × 2.8					
F8	1799	●Bongo, Truck ●Capera Cargo SS88U, GV8W	4	1	86 × 1.5 × 3.3		RF	SV	30660	F801-23-130 F2Y-1-11-SC0
				2	86 × 1.5 × 3.8					
				0	86 × 4 × 3.5					
				1	86 × 1.5 × 3.3			SV	30661	
				2	86 × 1.5 × 3.8					
				0	86 × 4 × 3.5					
FE	2000	●Bongo GVER, HCEP, HBEY, SREOW, SREAV ●Truck	4	1	86 × 1.5 × 3.3		GN	SV	30680	F2Y1-11-SC0 F2Y2-11-SC0
				2	86 × 1.5 × 3.8					
				0	86 × 4 × 3.4					
				1	86 × 1.5 × 3.3			SV	30682	
				2	86 × 1.5 × 3.8					
				0	86 × 4 × 3.4					
F8D			4	1	86 × 1.5 × 3.3			SV	30135	F8Y1-11-SC0
				2	86 × 1.5 × 3.8					
				0	86 × 4 × 3.4					
LFX	2000	●Atenza ●Axela ●Premacy	4	1	87.5 × 1.2 × 2.8		GN	SV	30790	LFY2-11-SC0
				2	87.5 × 1.2 × 3.3					
				0	87.5 × 2.5 × 2.65					
L3V-KAI	2300	●Axela	4	1	87.5 × 1.2 × 2.8			SV	30160	L3Y3-11-SC0
				2	87.5 × 1.2 × 3.3					
				0	87.5 × 2.5 × 2.65					
LFD	2000	●Atenza	4	1	87.5 × 1.2 × 2.8			SV	30155	LFY1-11-SC0A
				2	87.5 × 1.2 × 3.3					
				0	87.5 × 2.5 × 2.65					
L3T	2500	●Atenza ●Axela	4	1	87.5 × 1.5 × 3.1		GN	SM	30008	L3Y4-11-SC0
				2	87.5 × 1.5 × 3.7					
				0	87.5 × 2.0 × 2.0					
EXA	2522	●Center	4	1	88.9 × 2.383 × 3.5	RN		FO	30145	0559-23-206
				2	88.9 × 2.383 × 3.5	RN				
				3	88.9 × 2.383 × 3.5	RN				
				0	88.9 × 4.763 × 3.5	RN				
				0	88.9 × 4.763 × 3.5	RN				
L5X	2300	●Axela ●Biante ●Premacy	4	1	89 × 1.2 × 2.9		Cr1	SV	30009	L5Y3-11-SC0
				2	89 × 1.2 × 3.8					
				0	89 × 2.5 × 2.5					
JE	3000		6	1	90 × 1.5 × 3.3		GN	SV	30240	JEY1-11-SC0
				2	90 × 1.5 × 3.8					
				0	90 × 4 × 3.4					
G6			4	1	92 × 1.5 × 3.3			SV	30180	G601-11-SC0A
				2	92 × 1.5 × 4.1					
				0	92 × 4 × 3.4					
エンジン型式	排気量	車名・型式	シリン ダー数	位置	サイズ 径×中×厚さ	材質	表面改質	セットタイプ	セットNo.	備考
ピストンリング										

MAZDA MOTOR CORP.
マツダ(株)

Engine Type	cc	Vehicle Model Chassis Type	Cyl. No.	Piston Ring						Remarks
				Position	Size (mm) d ₁ ×h ₁ ×a ₁ (D×B×T)	Material	Surface Treatment	Set Type	Set No. ※	

統 MAZDA MOTOR CORP. マツダ(株)

○—ディーゼル車 Diesel-engine Automobiles

※(): OLD SET No.

PN	1720	●Familia Diesel BG7P	4	1	78 × 2 × 3.8		GN	SM	30875	PN11-11-SCO PNY2-11-SCOA
				2	78 × 1.5 × 3.2					
				0	78 × 3 × 2					
RF	2184	●Capera, Bongo Truck SSF8V, GVFB, GVFW	4	1	86 × 2 × 3.5	RN	Cr2	FX	30670	RF01-23-130A
				2	86 × 2 × 3.6					
				0	86 × 4 × 2.5					
				1	86 × 2 × 3.5	RN		FX	30777	
				2	86 × 2 × 3.6					
				0	86 × 4 × 2.5					
RFX	2000	●Capera	4	1	86 × 2 × 3.1		GN	SM	30117	RFY0-11-SCOD IST=KEYSTONE
				2	86 × 2 × 3.6					
				0	86 × 4 × 2.5					
R2	2184	●Bongo SR29V	4	1	86 × 2 × 3.5	RN	Cr2	FX	30850	R201-23-130A,B
				2	86 × 2 × 3.6					
				0	86 × 4 × 3.9					
				1	86 × 2 × 3.5	RN	Cr1	FX	30855 (30143)	
				2	86 × 2 × 3.6					
				0	86 × 4 × 3.9					
R2	2184	●Bongo SR29V	4	1	86 × 2 × 3.1		GN	SX	30330	R2B6-11-SCO
				2	86 × 2 × 3.7					
				0	86 × 3 × 2.1					
				1	86 × 2 × 3.1	RN	Cr1	SX	30335	
				2	86 × 2 × 3.7					
				0	86 × 3 × 2.1					
XA	2522	●Truck-E2500 EXA32S, 33S, 35S, 44S, 74S, EXB43S ●Bus AEKA, AEXB, AEXA	4	1	88.9 × 2.383 × 3.5	RN		FO	30701	0636-23-206 0636-23-207
				2	88.9 × 2.383 × 3.5					
				3	88.9 × 2.383 × 3.5					
				0	88.9 × 4.763 × 3.5	RN				
				0	88.9 × 4.763 × 3.5					
				0	88.9 × 4.763 × 3.5					
EXA	2522	●E2500	4	1	88.9 × 2.383 × 3.5	RN	Cr2	FO	30720	0559-23-206 0559-23-207
				2	88.9 × 2.383 × 3.5					
				3	88.9 × 2.383 × 3.5					
				0	88.9 × 4.763 × 3.5	RN				
				0	88.9 × 4.763 × 3.5					
				0	88.9 × 4.763 × 3.5					
YA	3883	●E3500	6	1	88.9 × 2.383 × 3.5	RN		FO	30710	0727-23-206 0727-23-210 0727-23-207
				2	88.9 × 2.383 × 3.5					
				3	88.9 × 2.383 × 3.5					
				0	88.9 × 4.763 × 3.5	RN				
				0	88.9 × 4.763 × 3.5					
				0	88.9 × 4.763 × 3.5					
EYA	3783	●E3500	6	1	88.9 × 2.383 × 3.5	RN	Cr2	FO	30730	0728-23-206 0728-23-209
				2	88.9 × 2.383 × 3.5					
				3	88.9 × 2.383 × 3.5					
				0	88.9 × 4.763 × 3.5	RN				
				0	88.9 × 4.763 × 3.5					
				0	88.9 × 4.763 × 3.5					
エンジン型式	排気量	車名・型式	シリン ダー数	位置	サイズ 径×中×厚さ	材質	表面改質	セットタイプ	セットNo.	備考
ピストンリング										

Engine Type	cc	Vehicle Model Chassis Type	Cyl. No.	Piston Ring						Remarks
				Position	Size (mm) d ₁ ×h ₁ ×a ₁ (D×B×T)	Material	Surface Treatment	Set Type	Set No. ※	

統 MAZDA MOTOR CORP. マツダ (株)

○ ——— ディーゼル車 Diesel-engine Automobiles

※ (): OLD SET No.

S2 XA	2209 2522	●Bongo, Diesel ●Luce(929L) LA48, BA258, BA259	4	1	88.9 × 2.393 × 3.5	RN	Cr2	FX	30190	1456-23-206					
				2	88.9 × 2.393 × 3.5	RN									
				0	88.9 × 4.763 × 2.9										
	EXC XB			2071	●Titan E2700	4	1	92 × 2.383 × 3.6	RN	Cr2	FO	30741	0528-23-206 0527-23-206		
							2	92 × 2.383 × 3.6	RN						
							3	92 × 2.383 × 3.6	RN						
EZA VB		4052	●Titan E4100 EZA, EZB				6	0	92 × 4.763 × 3.6	RN			30750	0785-23-206	
								0	92 × 4.763 × 3.6	RN					
								1	92 × 2.383 × 3.6	RN	Cr1	FO			30005
	ZB			4100	●Titan	6		2	92 × 2.383 × 3.6	RN			30230	V101-23-206	
								2	92 × 2.38 × 3.6						
								0	92 × 4.76 × 2.9						
K4		2000	●Titan Truck				4	1	92 × 2.832 × 3.8	RN		FX	30115	K480-23-206 1ST=KEYSTONE	
								2	92 × 2.4 × 3.8						
								0	92 × 4 × 2.6						
WL		●Bongo ●Friender	4	1	93 × 2.5 × 4			FX	30175	WLY1-11-SCO					
				2	93 × 2 × 4										
				0	93 × 3 × 2.7										
				WL	2500	●Pick-up Truk		1	93 × 2.5 × 3.5		GN	SM	30340		
								2	93 × 2 × 3.9						
								0	93 × 3 × 2		GN				
WL				1	93 × 2 × 3.3		GN	SM	30004	WLY6-11-SCO					
				2	93 × 1.5 × 3.35	RN									
				0	93 × 2 × 2		GN								
エンジン型式	排気量	車名・型式	シリン ダー数	位置	サイズ 径×中×厚さ	材質	表面改質	セットタイプ	セットNo.	備考					
ピストンリング															

MAZDA MOTOR CORP.
マツダ (株)

Engine Type	cc	Vehicle Model Chassis Type	Cyl. No.	Piston Ring						Remarks
				Position	Size (mm) d ₁ ×h ₁ ×a ₁ (D×B×T)	Material	Surface Treatment	Set Type	Set No. ※	

⑧MAZDA MOTOR CORP. マツダ(株)

○—ディーゼル車 Diesel-engine Automobiles

※(): OLD SET No.

HA	3000	●Titan D3000 WE, WOFI	4	1	95 × 2.38 × 3.6	RN	Cr2	FX	30370	1363-23-206
				2	95 × 2.38 × 3.6					
				0	95 × 4.76 × 2.9					
W9			4	1	95 × 2.5 × 3.5		GN	SM	30910	W9Y1-11-SC0
				2	95 × 2 × 3.9					
				0	95 × 3 × 2		GN			
HA	2977	●Titan D3000 E3000 W	4	1	95.025 × 2.38 × 3.5	RN	Cr2	FX	30371	SE01-23-206 SE01-23-130
				2	95.025 × 2.38 × 3.5					
				0	95.025 × 4.763 × 2.9					
WE	3000	●Pick-up Truk		1	96 × 2 × 3.3		GN	SM	30006	WEY1-11-SCO
				2	96 × 1.5 × 3.35	RN				
				0	96 × 2 × 2		GN			
SL	3455	●Titan, Truck	4	1	100 × 2.5 × 4.2	RN		FX	30140	SL01-23-206A IST=HALF KEYSTONE
				2	100 × 2 × 4.2					
				0	100 × 4.5 × 3.2					
SL	3455	●Titan, Truck	4	1	100 × 2.5 × 4.2	RN	Cr4	FX	30141	SL07-23-206A
				2	100 × 2 × 4.3					
				0	100 × 4.5 × 2.9					
SL	3455	●Titan, Truck ●Titan, Dump	4	1	100 × 2.5 × 4.2	RN	Cr2	FX	30045	SL50-11-SCO
				2	100 × 2 × 4.2					
				0	100 × 4.5 × 2.9					
TF	4000	●Titan	4	1	105.5 × 2.5 × 4.5	RN	Cr2	FX	30505	TF01-11-SCO IST=HALF KEYSTONE
				2	105.5 × 2 × 4.6					
				0	105.5 × 4.5 × 4.75					
TM			4	1	109 × 3 × 3.8		GN	SM	30675	TMYO-11-SCO
				2	109 × 2 × 4.5					
				0	109 × 3 × 2		GN			
エンジン型式	排気量	車名・型式	シリン ダー数	位置	サイズ 径×中×厚さ	材質	表面改質	セットタイプ	セットNo.	備考
ピストンリング										

Engine Type	cc	Vehicle Model Chassis Type	Cyl. No.	Piston Ring						Remarks
				Position	Size (mm) d ₁ ×h ₁ ×a ₁ (D×B×T)	Material	Surface Treatment	Set Type	Set No. ※	

●SUZUKI CORP. スズキ(株)

○——ガソリン車 Gasoline-engine Automobiles

※(): OLD SET No.

LJ50 ST10	539	●Carry ●Cervo ●Fronte ST10, AL10	3	1	61 × 1.18 × 2.6			SN	26010	12140-67011/cyl.			
				2	61 × 1.98 × 2.5				(27670)	12140-63871 12140-72810 IST,2ND=HALF KEYSTONE			
ST20			3	1	61 × 1.18 × 2.6			FE	26870	12140-67011/cyl.			
				2	61 × 1.98 × 2.5				(50870)	IST=FEROX COATING IST,2ND=HALF KEYSTONE			
F8A F5A(3cyl)	800	●Alut ●Fronte LJ80	4	1	62 × 1.5 × 2.8	RN		FV	26220	12140-73000			
				2	62 × 1.5 × 2.8				(27220)	12140-73010/cyl.			
				0	62 × 2.8 × 2.8				GN	SV	26866 (27866)	12140-73011	
				1	62 × 1.5 × 2.6								
				2	62 × 1.5 × 2.8								
0	62 × 2.8 × 2.8												
F8A(NEW)	797	●Y7A		1	62 × 1.2 × 2.3			SV	26201	12140-85050/cyl.			
				2	62 × 1.2 × 2.5				(13201)				
				0	62 × 2.8 × 2.8				GN				
F6A	657	●Alut ●YA1 AA6PA, DJ51T DL51V ●Alut Van ●YA1 AA6PA, DJ51T DL51V	3	1	65 × 1.2 × 2.3			Cr4	SV	26274	12140-50E50/cyl.		
				2	65 × 1.2 × 2.7					(13274)			
				0	65 × 2.5 × 2.5					GN	SV	26313 (13313)	12140-51E50/cyl.
				1	65 × 1.2 × 2.3								
				2	65 × 1.5 × 2.7								
				0	65 × 2.5 × 2.5					GN			
F6A			3	1	65 × 1 × 2.3			SV	26319	12140-70G10			
				2	65 × 1.2 × 2.7								
				0	65 × 2 × 2.5								
F6A-N			4	1	65 × 1 × 2.3			SV	26018	12140-51F10			
				2	65 × 1.2 × 2.6				GN				
				0	65 × 2 × 2.5								
Y7AT7			4	1	65 × 1.2 × 2.3			GN	SV	26015	12140-73D00		
				2	65 × 1.5 × 2.7								
				0	65 × 2.5 × 2.5							GN	
F10A	970	●SJ410, Alut Y80, Y84	4	1	65.5 × 1.5 × 2.7			Cr4	FV	26020	12140-75111/cyl.		
				2	65.5 × 1.5 × 2.7					(27470)	12140-75110		
				0	65.5 × 2.8 × 2.8					RN		FV	26030 (27340)
	1	65.5 × 1.5 × 2.7											
	2	65.5 × 1.5 × 2.7											
	0	65.5 × 2.8 × 2.8	RN	GN	SV	26868 (27868)	12140-75112/cyl. 12140-75113/cyl.						
	1	65.5 × 1.5 × 2.6											
	2	65.5 × 1.5 × 2.7											
	0	65.5 × 2.8 × 2.8											
L60	550		2	1	68 × 1.2 × 2.6			SN	26040	12140-67820/cyl.			
				2	68 × 2 × 2.5				(27540)	IST,2ND=HALF KEYSTONE			
K6A			4	1	68 × 1 × 2.55			SV	26195	12140-73G01			
				2	68 × 1.2 × 2.8								
				0	68 × 2 × 2.5								
エンジン型式	排気量	車名・型式	シリン ダー数	位置	サイズ 径×巾×厚さ	材質	表面改質	セットタイプ	セットNo.	備考			
ピストンリング													

Engine Type	cc	Vehicle Model Chassis Type	Cyl. No.	Piston Ring						Remarks
				Position	Size (mm) d ₁ ×h ₁ ×a ₁ (D×B×T)	Material	Surface Treatment	Set Type	Set No. ※	

統SUZUKI CORP. スズキ(株)

○——ガソリン車 Gasoline-engine Automobiles

※(): OLD SET No.

K10A	1600	●Wagon R	4	1	68 × 1 × 2.6			SV	26197	12140-73G01-00					
				2	68 × 1.2 × 2.8										
				0	68 × 2 × 2.5										
F8B	800	●Y64 ●SS80	3	1	68.5 × 1.5 × 2.7	RN		FV	26910 (27910)	12140-78411/cyl. 12140-78410					
				2	68.5 × 1.5 × 2.8										
				0	68.5 × 2.8 × 2.9										
					3	1	68.5 × 1.5 × 2.7		GN	SV	26856 (27856)	12140-78412/cyl.			
						2	68.5 × 1.5 × 2.8								
						0	68.5 × 2.8 × 2.9								
K12A	1200	●Swift	4	1	71 × 1 × 2.6			SV	26995	12140-75F30-000					
2	71 × 1.2 × 2.8														
0	71 × 2 × 2.5														
G10	1000		4	1	72 × 1.2 × 2.8		GN	SV	26285 (26085)	12140-72F00 (12140-72F00/cyl.)					
				2	72 × 1.5 × 3.2										
				0	72 × 2.8 × 2.8										
F10D	1061	●Zen Estilo	4	1	72 × 1.2 × 2.8		GN	SV	26230	12140-M72F10					
				2	72 × 1.5 × 3.2										
				0	72 × 2.8 × 2.8										
K10B	1000	●Alto	3	1	73 × 1 × 2.3		GN	SV	26037	12140-M68K60					
				2	73 × 1.2 × 2.5										
				0	73 × 2.0 × 2.2										
G13	1000	●Alto	3	1	74 × 1.2 × 2.8		Cr4	SV	26060 (13955)	12140-82161/cyl.					
				2	74 × 1.5 × 3.2										
				0	74 × 2.8 × 2.9										
G13A, G13B	1300	●Y2A SJ413	4	1	74 × 1.2 × 2.8		GN	SV	26070 (13490)	12140-82051					
				2	74 × 1.5 × 3.2										
				0	74 × 2.8 × 2.9										
				1	74 × 1.2 × 2.8										
				2	74 × 1.5 × 3.2										
				0	74 × 2.8 × 2.9										
		●Y2A		4	1	74 × 1.2 × 2.8		Cr1	SV	26492 (13492)					
					2	74 × 1.5 × 3.2									
					0	74 × 2.8 × 2.9									
SL413,G13BA Y2W-V	1300		4	1	74 × 1.2 × 2.8		GN	SV	26025	12140-63E50 (3CYL) 12140-65E50 (4CYL)					
				2	74 × 1.2 × 3.2										
				0	74 × 2.5 × 2.8										
G15A, G15B	1600	●Y0E-E	4	1	75 × 1.2 × 2.8		GN	SV	26251 (13251)	12140-60A50/cyl.					
				2	75 × 1.5 × 3.2										
				0	75 × 2.8 × 2.8										
									1		75 × 1.2 × 2.8		Cr1	SV	26110 (13001)
									2		75 × 1.5 × 3.2				
									0		75 × 2.8 × 2.8				
									0		75 × 2.8 × 2.8				
G15A, G16A	1600	●Y0E-E	4	1	75 × 1.2 × 2.8			SV	26140 (13280)	12140-61A00/cyl.					
				2	75 × 1.5 × 3.2										
				0	75 × 2.8 × 2.8										
エンジン型式	排気量	車名・型式	シリン ダー数	位置	サイズ 径×中×厚さ	材質	表面改質	セットタイプ	セットNo.	備考					
ピストンリング															

Engine Type	cc	Vehicle Model Chassis Type	Cyl. No.	Piston Ring						Remarks
				Position	Size (mm) d ₁ ×h ₁ ×a ₁ (D×B×T)	Material	Surface Treatment	Set Type	Set No. ※	

統SUZUKI CORP. スズキ(株)

○——ガソリン車 Gasoline-engine Automobiles

※(): OLD SET No.

GC415V	1495	●Carry ●Super Carry	4	1	75 × 1.2 × 2.8		GN	SV	26100	12140-61J00-00
				2	75 × 1.2 × 3.2					
				0	75 × 2.5 × 2.2					
G16B	1600	●YBI	4	1	75 × 1.2 × 2.8			SV	26024	12140-61G00/cyl.
				2	75 × 1.2 × 3.2					
				0	75 × 2.5 × 2.8					
G16U			4	1	75 × 1.2 × 2.8		GN	SV	26245	12140-61G50
				2	75 × 1.2 × 3.2					
				0	75 × 2.5 × 2.8					
RH413	1600	●Liana	4	1	78 × 1.2 × 2.7		GN	SV	26500	12040-54GA0-00
				2	78 × 1.2 × 3					
				0	78 × 2.5 × 2.5					
H20A		●Escudo	6	1	78 × 1.2 × 3.1			SV	26003	12140-85FA0
				2	78 × 1.48 × 3.4					
				0	78 × 2.5 × 2.65					
E12		●M13A ●M15A ●Swift	4	1	78 × 1.2 × 2.7		GN	SV	26007	12140-54G00
				2	78 × 1.2 × 2.3					
				0	78 × 2.5 × 2.65					
J18 J20	1800 2000	●Escudonomado	4	1	84 × 1.2 × 2.8		GN	SV	26008	12140-86FA0 12140-77E00
				2	84 × 1.5 × 3.5					
				0	84 × 2.5 × 2.8					
J20A	2000	●Escudo	4	1	84 × 1.2 × 2.5		GN	SV	26009	12140-65J00
				2	84 × 1.2 × 3.1					
				0	84 × 2.5 × 2.5					
H27	2700	●Escudo	6	1	88 × 1.2 × 3.3		GN	SV	26160	12140-52D00
				2	88 × 1.5 × 3.3					
				0	88 × 2.8 × 2.65					
A6B42 J24B	2400	●Kizashi	4	1	92 × 1.2 × 3.1			SV	26014	12140-78K00
				2	92 × 1 × 2.9					
				0	92 × 2 × 2.5					

エンジン型式	排気量	車名・型式	シリン ダー数	位置	サイズ 径×中×厚さ	材質	表面改質	セットタイプ	セットNo.	備考
--------	-----	-------	------------	----	------------	----	------	--------	--------	----

ピストンリング

Engine Type	cc	Vehicle Model Chassis Type	Cyl. No.	Piston Ring						Remarks
				Position	Size (mm) d ₁ ×h ₁ ×a ₁ (D×B×T)	Material	Surface Treatment	Set Type	Set No. ※	

●HONDA MOTOR CO., LTD. 本田技研工業(株)

○——ガソリン車 Gasoline-engine Automobiles

※(): OLD SET No.

N360 TN360	360	●N360, TN360	2	1	62.5 × 1.5 × 2.8			FV	16490	13011-567-325/cyl. 13011-601-000/cyl.		
				2	62.5 × 1.5 × 2.8							
				0	62.5 × 2.5 × 2.8							
ER	1200	●City Turbo	4	1	66 × 1.2 × 2.6			SV	16002 (29670)	13011-PD1-004/cyl.		
				2	66 × 1.2 × 2.9							
				0	66 × 2.8 × 2.8							
ER	1000	●City E-AA, L-VF	4	1	66 × 1 × 2.6			SV	16003 (29710)	13011-PC0-004/cyl.		
				2	66 × 1.2 × 2.9							
				0	66 × 2.8 × 2.8							
PZ3			4	1	66 × 1.2 × 2.45			SV	16815	13011-PZ3-003		
				2	66 × 1.2 × 2.6							
				0	66 × 2.8 × 2.5							
FA	360	●Life VA, PA ●Z360	2	1	67 × 1.5 × 2.8			FV	16350	13011-611-004/cyl.		
				2	67 × 1.5 × 2.8							
				0	67 × 2.8 × 2.8							
EB-1	1200	●Civic SB1	4	1	70 × 1.5 × 3	RN	Cr4	FV	16004 (29360)	13011-634-305/cyl. 13011-634-004/cyl. 13011-634-013 13011-634-003		
				2	70 × 1.5 × 3.3							
				0	70 × 2.8 × 2.9							
		●New Civic	4	1	70 × 1.5 × 3	RN	Cr4	FV	16005 (29410)	13011-PB0-004/cyl. 13011-634-631/cyl.		
				2	70 × 1.5 × 3.3							
				0	70 × 4 × 3.1							
EB-5	1400	●145 Coupe CD H1400	4	1	72 × 1.5 × 3.4	RN	Cr4	FV	16006 (29380)	13011-642-305/cyl. 13011-642-004/cyl.		
				2	72 × 1.5 × 3.4							
				0	72 × 2.8 × 2.8							
EJ, EN	1300	●Civic ●Ballade	4	1	72 × 1.5 × 3.1	RN		FV	16007 (29060)	13011-PA0-004/cyl.		
				2	72 × 1.5 × 3.4							
				0	72 × 4 × 3.1							
EJ, EN	1300	●Civic ●Civic Van J-VC ●Ballade	4	1	72 × 1.5 × 3.1	RN	Cr4	FV	16008 (29080)	13011-PA1-004/cyl. 13011-PA5-004/cyl. 13011-695-004/cyl. 13011-673-000/cyl.		
				2	72 × 1.5 × 3.4							
				0	72 × 4 × 3.1							
					4	1	72 × 1 × 2.8		Cr1	SV	16009 (29250)	13011-PA5-034/cyl. 13011-PA5-024/cyl. 13011-PA5-014/cyl.
						2	72 × 1.2 × 3.1					
						0	72 × 2.8 × 2.8					
EH	550	●TN Acty(4WD)	2	1	72 × 1.2 × 2.8			SV	16012 (29570)	13011-PE9-004/cyl.		
				2	72 × 1.2 × 3.1							
				0	72 × 4 × 3.1							
EH	550	●TN Acty	2	1	72 × 1 × 2.8			SV	16013 (29960)	13011-679-024/cyl.		
				2	72 × 1.2 × 3.1							
				0	72 × 4 × 3.1							
EH	550	●TN Acty	2	1	72 × 1.5 × 3.1	RN		FV	16014 (29950)	13011-679-621/cyl. 13011-679-014		
				2	72 × 1.5 × 3.4							
				0	72 × 4 × 3.1							
エンジン型式	排気量	車名・型式	シリン ダー数	位置	サイズ 径×中×厚さ	材質	表面改質	セットタイプ	セットNo.	備考		
ピストンリング												

Engine Type	cc	Vehicle Model Chassis Type	Cyl. No.	Piston Ring						Remarks
				Position	Size (mm) d ₁ ×h ₁ ×a ₁ (D×B×T)	Material	Surface Treatment	Set Type	Set No. ※	

統 HONDA MOTOR CO., LTD. 本田技研工業(株)

○——ガソリン車 Gasoline-engine Automobiles

※(): OLD SET No.

EH	550	●TN-Acty Acty Van	2	1	72 × 1.5 × 3.4			FV	16015 (29150)	13011-679-014/cyl.
				2	72 × 1.5 × 3.4					13011-679-004/cyl.
				0	72 × 4 × 3.1					
REA	1300	●Fit ●City	4	1	73 × 1 × 2.3		GN	SV	16585	13011-REA-F01
				2	73 × 1.2 × 3					
				0	73 × 2.8 × 2.5					
REA	1300	●Fit ●City	4	1	73 × 1 × 2.3			SV	16590	13011-REA-Z01
				2	73 × 1.2 × 3					
				0	73 × 2 × 2.2					
REA-2	1300 1500	●Fit ●City	4	1	73 × 1 × 2.3			SV	16072	13011-PWA-G01 13011-PWC-J01
				2	73 × 1.2 × 2.3					
				0	73 × 2 × 2.2					
RB1	1500	●Fit	4	1	73 × 1 × 2.3			SV	16058	13011-RB1-004
				2	73 × 1 × 2.3					
				0	73 × 2 × 2.2					(ALL STEEL)
EC	1500	●Civic H-VB	4	1	74 × 1.5 × 2.9	RN		FV	16016 (29350)	13011-657-315/cyl. 13011-657-305/cyl. 13011-657-604/cyl.
				2	74 × 1.5 × 3.2					
				0	74 × 2.8 × 3.4					
EM ED	1500	●Civic E-WD, E-SG, E-SH ●Ballade ●Accord B-SJ	4	1	74 × 1.5 × 2.9	RN		FV	16017 (29070)	13011-PA6-004/cyl. 13011-657-405/cyl. 13011-671-014/cyl. 13011-675-005/cyl. 13011-657-671/cyl. 13011-657-674/cyl.
				2	74 × 1.5 × 3.2					
				0	74 × 4 × 3.4					
EF	1600	●Civic	4	1	74 × 1.2 × 2.8			SV	16018 (29700)	13011-PA6-014/cyl.
				2	74 × 1.2 × 3.2					
				0	74 × 2.8 × 2.8					
EM	1500		4	1	74 × 1.5 × 3.4			FV	16500	13011-590-010/cyl.
				2	74 × 1.5 × 3.4					
				0	74 × 2.8 × 3.4					
EM	1500	●Civic ●Ballade	4	1	74 × 1.5 × 3.2			FE	16640	13011-568-010/cyl.
				2	74 × 1.5 × 3.2					
				0	74 × 2.5 × 3.2					
PE6	1300	●Civic 1300	4	1	74 × 1.2 × 2.8			SV	16019 (29540)	13011-PE0-663/cyl. 13011-PE0-662/cyl.
				0	74 × 2.8 × 2.8					
EF	1300	●Civic	4	1	74 × 1.2 × 2.8			SV	16023 (29290)	13011-PE1-004/cyl.
				2	74 × 1.2 × 3.2					
				0	74 × 2.8 × 2.8					
EV	1300	●Civic 1300	4	1	74 × 1.5 × 2.8		RF	SV	16024 (29940)	13011-PE3-004/cyl.
				2	74 × 1.5 × 3.2					
				0	74 × 4 × 3.5					
D15,B6	1500	●Civic	4	1	75 × 1 × 2.8			SV	16141	13011-PM8-A02/cyl.
				2	75 × 1.2 × 3.2					
				0	75 × 2.8 × 2.8					
エンジン型式	排気量	車名・型式	シリン ダー数	位置	サイズ 径×中×厚さ	材質	表面改質	セットタイプ	セットNo.	備考
ピストンリング										

Engine Type	cc	Vehicle Model Chassis Type	Cyl. No.	Piston Ring						Remarks
				Position	Size (mm) d ₁ ×h ₁ ×a ₁ (D×B×T)	Material	Surface Treatment	Set Type	Set No. ※	

統 HONDA MOTOR CO., LTD. 本田技研工業(株)

○——ガソリン車 Gasoline-engine Automobiles

※(): OLD SET No.

PM0 SH4	1500	●Civic	4	1	75 × 1.2 × 2.8		GN	SV	16151	13011-PM0-B02/cyl. 13011-PM0-B03/cyl.
				2	75 × 1.5 × 3.2					
				0	75 × 4 × 3.1					
P04	1500	●Civic	4	1	75 × 1.2 × 2.8			SV	16240 (29244)	13011-PO4-G02/cyl.
				2	75 × 1.5 × 3.2					
				0	75 × 2.8 × 2.8					
D15B D15BT	1500	●Civic	4	1	75 × 1.2 × 2.8			SV	16365 (16101)	13011-PM3-004/cyl. 13011-PM1-004/cyl. 13011-PM5-A02/cyl.
				2	75 × 1.5 × 3.2					
				0	75 × 2.8 × 2.8					
D15Z1	1500	●Civic	4	1	75 × 1 × 2.6			SV	16242 (29242)	13011-PO8-004/cyl.
				2	75 × 1.2 × 3					
				0	75 × 2.8 × 2.5					
P28	1500	●Civic	4	1	75 × 1.2 × 2.8		Cr4	SV	16261 (29261)	13011-P28-A02/cyl.
				2	75 × 1.5 × 3.2					
				0	75 × 2.8 × 2.5					
ZC	1500	●Civic	4	1	75 × 1.2 × 2.8		GN	SV	16161	13011-PM6-G02/cyl.
				2	75 × 1.5 × 3.2					
				0	75 × 2.8 × 2.5					
D15Z1			4	1	75 × 1 × 2.6			SV	16243	13011-P07-004
				2	75 × 1.2 × 3					
				0	75 × 2.8 × 2.5					
D16A			4	1	75 × 1 × 2.6		GN	SV	16010	13011-PJ1-Y01
				2	75 × 1.2 × 3					
				0	75 × 2.8 × 2.5					
D17A			4	1	75 × 1 × 2.6			SV	16040	13011-PLR-004 13011-PLM-A00
				2	75 × 1.2 × 3					
				0	75 × 2 × 2.2					
CF	1500		4	1	75 × 1 × 2.6			SV	16160	13011-PLG-G01
				2	75 × 1.2 × 3					
				0	75 × 2 × 2.2					
EK	1600	●Quint E-SU ●Accord E-SV	4	1	77 × 1.5 × 3.0	RN	Cr4	FV	16025 (29490)	13011-676-604/cyl. 13011-PB2-005/cyl. 13011-676-602/cyl. 13011-676-642/cyl.
				2	77 × 1.5 × 3.3					
				0	77 × 4 × 3.2					
EK EP	1800	●Accord E-SZ, E-SM ●Prelude	4	1	77 × 1.5 × 3.1		RF	SV	16026 (29390)	13011-689-005/cyl. 13011-689-015/cyl. 13011-689-003/cyl. 13011-PC3-602/cyl.
				2	77 × 1.5 × 3.3					
				0	77 × 4 × 3.2					
ES	1800	●Prelude	4	1	80 × 1.5 × 3.2	RN		FV	16027 (29140)	13011-PC6-004/cyl. 13011-PC6-013
				2	80 × 1.5 × 3.4					
				0	80 × 4 × 3.4					
A18A	1800	●Accord 1800	4	1	80 × 1.2 × 3.1			SV	16841 (29841)	13011-PH2-901,902/cyl. 13011-PH2-903/cyl.
				2	80 × 1.2 × 3.3					
				0	80 × 2.8 × 3.1					
エンジン型式	排気量	車名・型式	シリン ダー数	位置	サイズ 径×中×厚さ	材質	表面改質	セットタイプ	セットNo.	備考
ピストンリング										

Engine Type	cc	Vehicle Model Chassis Type	Cyl. No.	Piston Ring						Remarks
				Position	Size (mm) d ₁ ×h ₁ ×a ₁ (D×B×T)	Material	Surface Treatment	Set Type	Set No. ※	

統 HONDA MOTOR CO., LTD. 本田技研工業(株)

○——ガソリン車 Gasoline-engine Automobiles

※(): OLD SET No.

ES,EY	1800	●Accord 1800	4	1	80 × 1.5 × 3.1		RF	SV	16028 (29880)	13011-PC7-004/cyl.
				2	80 × 1.5 × 3.4					
				0	80 × 4 × 3.4					
ES EY	1829	●Accord ●Prelude	4	1	80 × 1.5 × 3.2	RN		FV	16029 (29800)	13011-PD6-004/cyl.
				2	80 × 1.5 × 3.4					
				0	80 × 4 × 3					
B18A B20A	2000	●Prelude 2000	4	1	81 × 1.2 × 3.1	RN	GN	SV	16039 (29901)	13011-PJ5-602/cyl.
				2	81 × 1.5 × 3.2					
				0	81 × 2.8 × 3.1		GN			
B20A	1800	●Accord ●Prelude	4	1	81 × 1.2 × 3.1			SV	16031	13011-PK1-004/cyl. 13011-PK1-003/cyl.
				2	81 × 1.5 × 3.4					
				0	81 × 2.8 × 3.1					
	1800	●Accord ●Prelude	4	1	81 × 1.2 × 3.1	RN	GN	SV	16091	13011-PK1-752/cyl. 13011-PK1-751/cyl.
				2	81 × 1.5 × 3.2					
				0	81 × 2.8 × 3.1		GN			
B16A B18A	1600	●Integra	4	1	81 × 1 × 3.1			SV	16033 (29011)	13011-PR3-004/cyl. 13011-PR4-A02/cyl. 13011-PR3-003
				2	81 × 1.2 × 3.3					
				0	81 × 2.8 × 2.55					
B16A	1800	●Integra	4	1	81 × 1 × 3.1		GN	SV	16034 (29022)	13011-PR4-Y02/cyl.
				2	81 × 1.2 × 3.3					
				0	81 × 2.8 × 2.5		GN			
R18A	1800	●Civic	4	1	81 × 1.2 × 2.5			SV	16057	13011-RNA-A02 13011-RNA-A01
				2	81 × 1.2 × 3.4					
				0	81 × 2 × 2.5					
R20A	2000	●Accord ●CR-V	4	1	81 × 1.2 × 2.5			SV	16047	13011-RZP-004
				2	81 × 1.2 × 3.4					
				0	81 × 2 × 2.5					
C20A	2000	●Ascot ●Sabar ●Rafarga ●Inspire	4	1	82 × 1.2 × 3.1			SV	16035 (29071)	13011-PV0-004/cyl. 13011-PV0-014/cyl.
				2	82 × 1.2 × 3.3					
				0	82 × 2.8 × 2.8					
A20A	2000	●Prelude 2000	4	1	82.7 × 1.5 × 3.1	RN	GN	SV	16485 (29485)	13011-PH4-651/cyl. 13011-PH4-602/cyl. (o/s 0.3mm) 13011-PH4-651
				2	82.7 × 1.5 × 3.2					
				0	82.7 × 4 × 3.4		GN			
	2000	●Prelude 2000	4	1	82.7 × 1.5 × 3.1	RN	Cr1	SV	16165 (29165)	(o/s 0.3mm)
				2	82.7 × 1.5 × 3.2					
				0	82.7 × 4 × 3.4		GN			
2000	●Prelude 2000	4	1	82.7 × 1.5 × 3.1	RN	GN	SV	16482 (29482)	13011-PH4-602/cyl. (STD, 0.10 ~ 040 o/s)	
			2	82.7 × 1.5 × 3.2						
			0	82.7 × 4 × 3.4		GN				
エンジン型式	排気量	車名・型式	シリン ダー数	位置	サイズ 径×中×厚さ	材質	表面改質	セットタイプ	セットNo.	備考
ピストンリング										

Engine Type	cc	Vehicle Model Chassis Type	Cyl. No.	Piston Ring						Remarks
				Position	Size (mm) d ₁ ×h ₁ ×a ₁ (D×B×T)	Material	Surface Treatment	Set Type	Set No. ※	

統 HONDA MOTOR CO., LTD. 本田技研工業(株)

○——ガソリン車 Gasoline-engine Automobiles

※(): OLD SET No.

A20A	1800	●Accord	4	1	82.7 × 1.5 × 3.1		CrI	SV	16731	13011-PH4-004/cyl. 13011-PH4-751
				2	82.7 × 1.5 × 3.5					
				0	82.7 × 4 × 3.4					
C25A	2500	●Legend	6	1	84 × 1.2 × 3.1			SV	16531 (29531)	13011-PH7-004/cyl.
				2	84 × 1.2 × 3.7					
				0	84 × 4 × 3.4					
B20B	2200		4	1	84 × 1.2 × 3.1		GN	SV	16205	13011-P3F-003
				2	84 × 1.2 × 3.4					
				0	84 × 2.8 × 2.5					
F20A	2200	●Accord ●Ascot	4	1	85 × 1.2 × 3.1		GN	SV	16063 (29063)	13011-PT0-B02/cyl. 13011-PTO-B01
				2	85 × 1.2 × 3.4					
				0	85 × 2.8 × 2.8					
F22A	2200	●Accord ●Ascot	4	1	85 × 1.2 × 3.1			SV	16061 (29061)	13011-PT0-004/cyl.
				2	85 × 1.2 × 3.4					
				0	85 × 2.8 × 2.8					
F22A,F22B	2500 2200	●Sabar ●Accord ●Prelude	4	1	85 × 1.2 × 3.1		GN	SV	16203 (29203)	13011-PT0-B04/cyl. 13011-PTO-B03
				2	85 × 1.2 × 3.4					
				0	85 × 2.8 × 2.8					
F20A	2200	●Accord ●Ascot	4	1	85 × 1.2 × 3.1			SV	16036 (29031)	13011-PT1-004/cyl. 13011-PT1-G02/cyl.
				2	85 × 1.2 × 3.4					
				0	85 × 2.8 × 2.8					
F22B	2200	●Accord ●Ascot	4	1	85 × 1.2 × 3.1			SV	16032 (29032)	13011-PT2-004/cyl.
				2	85 × 1.2 × 3.4					
				0	85 × 2.8 × 2.8					
PT4	2200	●Accord ●Ascot	4	1	85 × 1.2 × 3.1		GN	SV	16202 (29202)	13011-PT4-X04/cyl. 13011-PT4-X02/cyl. 13011-PT4-X01/cyl. 13011-PT4-X03/cyl.
				2	85 × 1.2 × 3.4					
				0	85 × 2.8 × 2.8					
F23A			4	1	86 × 1.2 × 3.1		GN	SV	16054 (29002)	13011-PN8-P01 13011-PAA-Y01
				2	86 × 1.2 × 3.4					
				0	86 × 2.8 × 2.8					
F23A	2300	●Odyssey	4	1	86 × 1.2 × 3.1			SV	16056	13011-PEA-004
				2	86 × 1.2 × 3.4					
				0	86 × 2.8 × 2.8					
K20A1	2000		4	1	86 × 1.2 × 3.1			SV	16400	13011-PNE-G02
				2	86 × 1.2 × 3.4					
				0	86 × 2 × 2.5					
K20A4	2000		4	1	86 × 1.2 × 3.1		GN	SV	16060	13011-PNB-G01
				2	86 × 1.2 × 3.4					
				0	86 × 2.8 × 2.8					
K24A4		●Accord ('03)	4	1	87 × 1.2 × 3.1		GN	SV	16059	13011-RAF-S01
				2	87 × 1.2 × 3.4					
				0	87 × 2.8 × 2.65					
C27A	2700	●Legend	6	1	87 × 1.2 × 3.1			SV	16011	13011-PL2-004/cyl. 13011-PL2-003/cyl.
				2	87 × 1.2 × 3.7					
				0	87 × 4 × 3.4					
エンジン型式	排気量	車名・型式	シリン ダー数	位置	サイズ 径×巾×厚さ	材質	表面改質	セットタイプ	セットNo.	備考
ピストンリング										

Engine Type	cc	Vehicle Model Chassis Type	Cyl. No.	Piston Ring						Remarks
				Position	Size (mm) d ₁ ×h ₁ ×a ₁ (D×B×T)	Material	Surface Treatment	Set Type	Set No. ※	

統 HONDA MOTOR CO., LTD. 本田技研工業(株)

○——ガソリン車 Gasoline-engine Automobiles

※(): OLD SET No.

POF, PON H22,A3 P5M, P5D	2200	●Accord ●Prelude	4	1	87 × 1.2 × 3.1	RN	GN	SV	16271 (29271)	13011-PI3-003/cyl. 13011-P5M-002 13011-P5M-003
				2	87 × 1.2 × 3.2					
				0	87 × 2.8 × 2.65					
RAD PPA	2400	●Edix ●Elision	4	1	87 × 1.2 × 3.1			SV	16053	13011-RAD-004 13011-PPA-004
				2	87 × 1.2 × 3.4					
				0	87 × 2 × 2.5					
RZA	2400	●CR-V	4	1	87 × 1.2 × 3.1			SV	16046	13011-RZA-004
				2	87 × 1.2 × 3.4					
				0	87 × 2 × 2.5					
K24A	2400	●Accord	4	1	87 × 1.2 × 2.7	RN		SV	16048	13011-R40-A01
				2	87 × 1.2 × 3.4					
				0	87 × 2 × 2.5					
FCG			4	1	87 × 1.2 × 3.1			SV	16082	13011-POG-A02
				2	87 × 1.2 × 3.7					
				0	87 × 4 × 3.4					
J35A	3500	●Accord	6	1	89 × 1.2 × 3.1			SV	16049	13011-R70-A01
				2	89 × 1.2 × 3.6					
				0	89 × 2.8 × 2.8					
C30A	2900	●Legend ●Sabar	6	1	90 × 1.2 × 3.3			SV	16037 (29221)	13011-PY3-004/cyl.
				2	90 × 1.2 × 3.7					
				0	90 × 2.8 × 3.1					
C32A	3200	●NSX	6	1	90 × 1.2 × 3.3		GN	SV	16038 (29231)	13011-PY3-Y02/cyl.
				2	90 × 1.2 × 3.7					
				0	90 × 2.8 × 3.1					
エンジン型式	排気量	車名・型式	シリン ダー数	位置	サイズ 径×巾×厚さ	材質	表面改質	セットタイプ	セットNo.	備考
ピストンリング										

Engine Type	cc	Vehicle Model Chassis Type	Cyl. No.	Piston Ring						Remarks
				Position	Size (mm) d ₁ ×h ₁ ×a ₁ (D×B×T)	Material	Surface Treatment	Set Type	Set No. ※	

●HYUNDAI

○——ガソリン車 Gasoline-engine Automobiles

※(): OLD SET No.

G4HA	798	●'97 AT08	4	1	63 × 1.2 × 2.3			SV	40042	23040-02500 23040-02511
				2	63 × 1.5 × 2.8					
				0	63 × 2.8 × 2.8					
ESPILON 1.1 G4HC	1100	●'98 ATOZ,1,000c.c	4	1	66 × 1.2 × 2.25			SV	40527	23040-02700
				2	66 × 1.2 × 2.8					
				0	66 × 2.5 × 2.8					
G4HG	1100	I10/1.1 ●KIA PICANTO	4	1	67 × 1.2 × 2.3			SV	40990	23040-02950 23040-02970
				2	67 × 1.2 × 2.9					
				0	67 × 2 × 2.8					
		●Santro	4	1	67 × 1.2 × 2.3		GN	SV	40910	23040-02820
				2	67 × 1.2 × 2.8					
				0	67 × 2.5 × 2.5					
X11			4	1	71 × 1.5 × 2.65			SV	40069	23040-24200 23040-24010
				2	71 × 1.5 × 3.1					
				0	71 × 3 × 3.25					
ALPHA 1.3 G4EH	1300	●'94 ACCENT '94 ACCENT ES '94 ACCENT MuLT1	4	1	71.5 × 1.5 × 2.9			FV	40770	23040-22300 23040-22351
				2	71.5 × 1.5 × 3.1					
				0	71.5 × 3 × 2.7					
G4EK Alpha1.5	1500	●Accent ●Avante	4	1	75 × 1.2 × 2.85			SV	40063	23010-26001
				2	75 × 1.5 × 3.1					
				0	75 × 3 × 2.75					
G4BK G4EK EXCEL 1.5	1500	●'80 EXCEL,1,500c.c	4	1	75.5 × 1.5 × 3.2			FV	40163	23431-21110
				2	75.5 × 1.5 × 3.2					
				0	75.5 × 4 × 3.1					
ALPHA 1.5 G4BK G4AE	1500	●'94 ACCENT,1,500cc '94 ACCENT PRO,1,500c.c '94 ACCENT EURO,1,500c.c	4	1	75.5 × 1.5 × 3.2	RN		FV	40765	23040-22010
				2	75.5 × 1.5 × 3.2					
				0	75.5 × 3 × 3.1					
G4BB G4EE	1400	●Click ●'06 ~ '10 ACCENT ●KIA R10	4	1	75.5 × 1.2 × 2.9			SV	40112	23040-26002 23040-26112
				2	75.5 × 1.2 × 3.3					
				0	75.5 × 2 × 2.8					
G4ED	1600	●Elentra ●Santa Fe	4	1	76.5 × 1.2 × 2.9			SV	40070	23040-26101
				2	76.5 × 1.2 × 3.2					
				0	76.5 × 2.5 × 3.1					
		●Cerato	4	1	76.5 × 1.2 × 2.7		GN	SV	40064	23040-26151
				2	76.5 × 1.2 × 3.2					
				0	76.5 × 2.5 × 2.8					
	1600	●Verna ●'05 KIA RIO	4	1	76.5 × 1.2 × 2.85	RN		FV	40082	23040-26160
				2	76.5 × 1.2 × 3.2					
				0	76.5 × 2 × 2.75					
		●Elantra	4	1	77 × 1.2 × 2.6			SV	40166	23040-2B001
				2	77 × 1.2 × 3.1					
				0	77 × 2 × 2.5					
G4DR J2	1600	●ELANTRA 1.6	4	1	77.4 × 1.2 × 2.75			SV	40837	23040-23100 23040-23150
				2	77.4 × 1.2 × 3.3					
				0	77.4 × 2.5 × 3.1					
エンジン型式	排気量	車名・型式	シリン ダー数	位置	サイズ 径×中×厚さ	材質	表面改質	セットタイプ	セットNo.	備考
ピストンリング										

Engine Type	cc	Vehicle Model Chassis Type	Cyl. No.	Piston Ring						Remarks
				Position	Size (mm) d ₁ ×h ₁ ×a ₁ (D×B×T)	Material	Surface Treatment	Set Type	Set No. ※	

統HYUNDAI

○—ガソリン車 Gasoline-engine Automobiles

※(): OLD SET No.

G4GB	1800	●ELANTRA 1.6	4	1	82 × 1.2 × 3.05			SV	40832	23040-23000
				2	82 × 1.2 × 3.5					23040-23050
				0	82 × 2.5 × 3.1					23040-23200
3F G4FC			4	1	82 × 1.2 × 2.8			SV	40162	23040-23300
				2	82 × 1.2 × 3.2					
				0	82 × 2 × 2.55					
G4CR	1595	●ELANTRA	4	1	82.3 × 1.2 × 3.1			FV	40101	23040-33030
				2	82.3 × 1.5 × 3.8					
				0	82.3 × 3 × 2.8					
G4CP2.0		●Sonata	4	1	85 × 1.2 × 3.1		GN	SV	40325	23040-33110
				2	85 × 1.5 × 3.8					23040-33140
				0	85 × 3 × 2.8		GN			
Y2			4	1	85 × 1.5 × 3.3			SV	40066	23040-32800
				2	85 × 1.5 × 3.7					23040-32820
				0	85 × 4 × 3.15					
EF,EF2		●Sonata	4	1	85 × 1.2 × 3.1			SV	40091	23040-38100
				2	85 × 1.5 × 3.8					
				0	85 × 2.8 × 2.5					
		●Sportage (Kia)	4	1	86 × 1.2 × 3.1			SV	40124	23040-25000
				2	86 × 1.2 × 3.6					
				0	86 × 2 × 2.5					
Y2	2400	●Grace (New) ●Grandeur ●Grace Grand Salon	4	1	86.5 × 1.5 × 3.5			SV	40044	23040-32610
				2	86.5 × 1.5 × 3.8					
				0	86.5 × 4 × 3.4					
エンジン型式	排気量	車名・型式	シリンダー数	位置	サイズ 径×巾×厚さ	材質	表面改質	セットタイプ	セットNo.	備考
ピストンリング										

Engine Type	cc	Vehicle Model Chassis Type	Cyl. No.	Piston Ring						Remarks
				Position	Size (mm) d ₁ ×h ₁ ×a ₁ (D×B×T)	Material	Surface Treatment	Set Type	Set No. ※	

統HYUNDAI

○—ディーゼル車 Diesel-engine Automobiles

※(): OLD SET No.

D4FA			4	1	75 × 1.75 × 2.9			SM	40218	23040-2A900
				2	75 × 1.75 × 2.9					
				0	75 × 3 × 2					
2DN	1500	●Accent	4	1	83 × 1.915 × 3.1			SM	40089	23040-27920
				2	83 × 2 × 3.75					
				0	83 × 3 × 2					
D4EB			4	1	87 × 2.43 × 3.1			SM	40216	23040-27940 23040-27980
				2	87 × 2 × 3.5					
				0	87 × 3 × 2					
1 TON (NEW) (H 100)		●'88 GRACE PORTER 1 TON, 1.25TON	4	1	91.1 × 2.5 × 3.7	RN	RF Cr1 GN	FM	40695	23040-42000
				2	91.1 × 2 × 3.7					
				0	91.1 × 4 × 4.4					
T,T2 H1,H100 D4BA	2500	●'89 PORTER 1.25TON '89 PORTER SUPER GAP '93 GRACE (NEW), PORTER(NEW) STAREX	4	1	91.1 × 2 × 3.3		GN Cr1 GN	SM	40525	23040-42200 23040-42202 23040-42210
				2	91.1 × 2 × 3.8					
				0	91.1 × 3 × 3.35					
1TON(NEW) D4BA	2400	●Grace ●Porter ●Galoper	4	1	91.1 × 2 × 3.3		GN	SM	40071	23040-42010
				2	91.1 × 2 × 3.8					
				0	91.1 × 4 × 4.35					
D4CB	2500	●Porter ii ●Sorento	4	1	91.1 × 2.42 × 3.3		GN GN	SM	40119	23040-4A900 IST=HALF KEYSTONE
				2	91.1 × 2 × 3.9					
				0	91.1 × 3 × 2					
M96TC		●'96 Galoper T/C	4	1	91.1 × 2.5 × 3.7	RN RN		FM	40699	23040-42540
				2	91.1 × 1.95 × 3.7					
				0	91.1 × 4 × 2.5					
		●Terracan	4	1	97.1 × 2.42 × 3.3		GN GN	SM	40093	23040-4X900 IST=HALF KEYSTONE
				2	97.1 × 2 × 3.9					
				0	97.1 × 3 × 2					
D4AE		●'97 MIGHTY 3.5ton	4	1	100 × 3 × 4			FM	40100	23040-41400 IST=KEYSTONE
				2	100 × 2 × 4					
				0	100 × 4 × 2.5					
D4AF			4	1	100 × 3 × 3.65			FX	40067	23040-41600 23040-41060
				2	100 × 2 × 4.2					
				0	100 × 5 × 4.95					
D4AF K-1	3567	●Mighty	4	1	104 × 2.97 × 4.1			FM	40096	23040-41200
				2	104 × 2 × 4.2					
				0	104 × 4 × 2.5					
D6BR 6D16	7545	●4.5tonTruck ●5tonTruck	6	1	118 × 3 × 4.6			FX	40098	23040-93000
				2	118 × 2.5 × 4.6					
				0	118 × 4 × 3.3					
D6AB D6AC 6D22(OLD)	11149	●Aero City ●Aero Town ●Aero Express HSX	6	1	130 × 3.297 × 5.4	RN RN	Cr4	FM	40061	23040-83020 23040-83030
				2	130 × 3 × 5.3					
				0	130 × 4 × 2.45					
エンジン型式	排気量	車名・型式	シリン ダー数	位置	サイズ 径×中×厚さ	材質	表面改質	セットタイプ	セットNo.	備考
ピストンリング										

Engine Type	cc	Vehicle Model Chassis Type	Cyl. No.	Piston Ring					Remarks
				Position	Size (mm) d ₁ ×h ₁ ×a ₁ (D×B×T)	Material	Surface Treatment	Set Type	

統HYUNDAI

○—ディーゼル車 Diesel-engine Automobiles

※(): OLD SET No.

D6CA			6	1	133 × 3.317 × 5.4	RN		FM	40114	23430-84010
				2	133 × 3 × 5.4	RN				
				0	133 × 4 × 2.45					IST=KEYSTONE
D8AX 8DC91A(NEW)	16031	● 15tonTruck ● 18tonTruck	8	1	135 × 3.3 × 5.4			FM	40097	23040-72020
				2	135 × 3 × 5.5					
				3	135 × 3 × 5.5					
				0	135 × 4 × 2.95					

--	--	--	--	--	--	--	--	--	--	--

エンジン型式	排気量	車名・型式	シリン ダー数	位置	サイズ 径×巾×厚さ	材質	表面改質	セットタイプ	セットNo.	備考
--------	-----	-------	------------	----	------------	----	------	--------	--------	----

ピストンリング

Engine Type	cc	Vehicle Model Chassis Type	Cyl. No.	Piston Ring						Remarks
				Position	Size (mm) d ₁ ×h ₁ ×a ₁ (D×B×T)	Material	Surface Treatment	Set Type	Set No. ※	

●KIA

○——ガソリン車 Gasoline-engine Automobiles

※(): OLD SET No.

B1	1000	●'86 PRIDE,1,000 POP	4	1	68 × 1.2 × 2.5	RN		FV	40486	KK1Y8-11-SCO
				2	68 × 1.5 × 2.8					
				0	68 × 3 × 2.8					
	800	●Jade ●Towner	3	1	70 × 1.2 × 2.5		GN	SV	40068	KOBM1-11-SCO
				2	70 × 1.5 × 3					
				0	70 × 2.8 × 2.85		GN			
B3	1300	●'86 PRIDE,1,300 DM, FS, CD	4	1	71 × 1.2 × 2.6			SV	40738	K1Y0-11-SCO K1Y1-11-SCO
				2	71 × 1.5 × 2.9					
				0	71 × 3 × 2.8					
B3	1300	●'86 PRIDE,1,300 GM, FESTIVA	4	1	71 × 1.2 × 2.5		GN	SV	40011	K1YH-11-SCO
				2	71 × 1.5 × 3.1					
				0	71 × 3 × 2.8		GN			
	1300	●PRIDE, EURO4	4	1	71 × 1.2 × 2.5		GN	SV	40213	560852-401
				2	71 × 1.5 × 3.1					
				0	71 × 3 × 2.8		GN			
R10	1500		4	1	75.5 × 1.2 × 2.9			SV	40880	OK3Y0-11-SCO
				2	75.5 × 1.2 × 3.3					
				0	75.5 × 2.5 × 2.8					
	1600	●Spectra	4	1	78 × 1.2 × 3.3			SV	40139	OK3Y3-11-SCO
				2	78 × 1.2 × 3.4					
				0	78 × 2.5 × 2.8					
B6D		●AVELLA	4	1	78 × 1.5 × 3.3	RN		FV	41195	K2YA-11-SCO K2Y2 -11-SCO
				2	78 × 1.5 × 3.4					
				0	78 × 3 × 3.1					
KV20			4	1	78 × 1.5 × 3.25			SV	41320	K9Y1 -11-SCO
				2	78 × 1.5 × 3.4					
				0	78 × 4 × 3.4					
K2			4	1	81 × 1.5 × 3.3		GN	SV	40510	K2Y3-11-SCO
				2	81 × 1.5 × 3.4					
				0	81 × 3 × 3.1		GN			
G4KC,KE		●Forte Sonata	4	1	88 × 1.2 × 2.9			SV	40168	23040-2G200
				2	88 × 1.2 × 3.6					
				0	88 × 2 × 2.5					
エンジン型式	排気量	車名・型式	シリン ダ-数	位置	サイズ 径×中×厚さ	材質	表面改質	セットタイプ	セットNo.	備考
ピストンリング										

Engine Type	cc	Vehicle Model Chassis Type	Cyl. No.	Piston Ring						Remarks
				Position	Size (mm) d ₁ ×h ₁ ×a ₁ (D×B×T)	Material	Surface Treatment	Set Type	Set No. [※]	

統KIA

○——ディーゼル車 Diesel-engine Automobiles

※(): OLD SET No.

R2, NB7	2184		4	1	86 × 2 × 3.1		GN	SM	40240	K7Y1-11-SCO
				2	86 × 2 × 3.6					
				0	86 × 3 × 2					
NB1(NEW)	2400	●NEW BESTA	4	1	86 × 2 × 3.5	RN		FM	41247	K7Y0-11-SCO
				2	86 × 2 × 3.5					
				0	86 × 4 × 2.5					
S2 XA	2209	●Bongo ●Ceres	6	1	88.925 × 2.383 × 3.45	RN		FX	40043	K6Z0-11-SCO
				2	88.925 × 2.383 × 3.5					
				0	88.925 × 4.763 × 2.9					
SF	2400	●K-2400 POWER BONGO WIDE BONGO	4	1	92 × 2.4 × 3.8	RN		FX	41177	K756-23-206 K7Z0-11-SCO
				2	92 × 2.4 × 3.8					
				0	92 × 4 × 4.35					
SS/SUTC	2700	●K-2700,1.4TON H1 TOPIC	4	1	92 × 2.85 × 3.8	RN		FX	41265	K4Z0-11-SCO K480-23-206 1ST=KEYSTONE
				2	92 × 2.4 × 3.6					
				0	92 × 4 × 4.1					
SF	2400	●K-2400-'92 ●Bongo	4	1	92 × 2.38 × 3.6			FX	40545	K7Z0-11-SCO
				2	92 × 2.38 × 3.6					
				0	92 × 4 × 2.8					
ZB	4100	●K4100	6	1	92.025 × 2.383 × 3.6	RN		FX	40047	K8Y1-11-SCO
				2	92.025 × 2.383 × 3.6					
				0	92.025 × 4.763 × 2.9					
RFA	2700	●HI-BESTA 2.7	4	1	93 × 2 × 3.3			SM	40513	VNY1-11-SCO
				2	93 × 2 × 3.7					
				0	93 × 3 × 4.1					
JS	2700	●K-2700, PREGIO	4	1	94.5 × 2 × 3.25		Cr1	SM	40025	K6Z1-11-SCO
				2	94.5 × 2 × 4					
				0	94.5 × 3 × 3.5					
K2700	3600	●PRBAIO	4	1	94.5 × 2 × 3.3		GN	SM	40528	K6Z1-11-SCO
				2	94.5 × 2 × 4					
				0	94.5 × 3 × 2					
HAI	2957	●K3000 ●Super Titan	4	1	95 × 2.38 × 3.9			FX	40090	KOYO-11-SCO
				2	95 × 2.38 × 3.9					
				0	95 × 4 × 3					
J3		●Carnival Diesel	4	1	97.1 × 2 × 3.5		GN	SM	41001	K5Z1-11-SCO
				2	97.1 × 2 × 3.8					
				0	97.1 × 3 × 3.5					
JT	3600	●K3600	4	1	98 × 2 × 3.6	RN	Cr4	FM	41175	K7Z1-11-SCO
				2	98 × 2 × 4					
				0	98 × 3 × 2.5					
SH3.6L		●TRADE FRONTIER 2.5	4	1	100 × 2 × 3.75			SM	41155	K4Y1-11-SCO
				2	100 × 2 × 4.2					
				0	100 × 3 × 2					
エンジン型式	排気量	車名・型式	シリン ダー数	位置	サイズ 径×中×厚さ	材質	表面改質	セットタイプ	セットNo.	備考
ピストンリング										

Engine Type	cc	Vehicle Model Chassis Type	Cyl. No.	Piston Ring					Remarks
				Position	Size (mm) d ₁ ×h ₁ ×a ₁ (D×B×T)	Material	Surface Treatment	Set Type	

●ASIA

○——ガソリン車 Gasoline-engine Automobiles

※(): OLD SET No.

JADE CD800	800	●TOWNER	4	1	70 × 1.2 × 2.6		GN	SV	12310	AA100-11-120
				2	70 × 1.5 × 3					2ND=INTERRUPT
				0	70 × 2.8 × 2.8					GN
JADE		●TOWNER	3	1	70 × 1.2 × 2.6		GN	SV	40310	AA100-11-120
				2	70 × 1.5 × 3					2ND=INTERRUPT
				0	70 × 2.8 × 2.8					GN

エンジン型式	排気量	車名・型式	シリン ダー数	位置	サイズ 径×巾×厚さ	材質	表面改質	セットタイプ	セットNo.	備考
--------	-----	-------	------------	----	------------	----	------	--------	--------	----

ピストンリング

Engine Type	cc	Vehicle Model Chassis Type	Cyl. No.	Piston Ring					Remarks
				Position	Size (mm) d ₁ ×h ₁ ×a ₁ (D×B×T)	Material	Surface Treatment	Set Type	

統ASIA

○—ディーゼル車 Diesel-engine Automobiles

※(): OLD SET No.

EM100	9419	● Trade ● Frontier 2.5	6	1	124 × 2.8 × 5	RN		FX	40086	EA1522-2010AS
				2	124 × 2.5 × 5	RN				
				3	124 × 3 × 5					
				0	124 × 5 × 3.5					
エンジン型式	排気量	車名・型式	シリンダー数	位置	サイズ 径×巾×厚さ	材質	表面改質	セットタイプ	セットNo.	備考
ピストンリング										

Engine Type	cc	Vehicle Model Chassis Type	Cyl. No.	Piston Ring						Remarks
				Position	Size (mm) d ₁ ×h ₁ ×a ₁ (D×B×T)	Material	Surface Treatment	Set Type	Set No. ※	

●DAEWOO

○——ガソリン車 Gasoline-engine Automobiles

※(): OLD SET No.

YSE,F6B	600	●TICO	3	1	68.5 × 1.2 × 2.55	RN		SV	40021	12140-78B00
				2	68.5 × 1.5 × 2.8					
				0	68.5 × 2.8 × 2.8					
3EA,YSE			3	1	68.5 × 1.2 × 2.65			SV	40065	96325192
				2	68.5 × 1.2 × 2.8					
				0	68.5 × 2.5 × 2.8					
4EA		●Chevrolet Spark7.24	4	1	68.5 × 1.2 × 2.65			SV	40105	96325192
				2	68.5 × 1.2 × 2.8					
				0	68.5 × 2.5 × 2.8					
		●N200/N300/M300	4	1	69.7 × 1.2 × 2.5			SV	40151	93744884 24545481
				2	69.7 × 1.2 × 2.8					
				0	69.7 × 2 × 2.5					
	1600	●Chev Sail	4	1	73.8 × 1.2 × 2.5	RN	GN	SV	40172	93736247
				2	73.8 × 1.2 × 2.8					
				0	73.8 × 2 × 2.5					
	1300	●Chevrolet Corsa1.3	4	1	75 × 1.5 × 3.3			SV	40120	93244958
				2	75 × 1.5 × 3.3					
				0	75 × 3 × 2.8					
SOHC/DOHC	1500	●'85 LEMAN 1.5L '91 ESPRESO,NUBIRA '95 CIELO, NEXIA 1.5L '96 LANOS	4	1	76.5 × 1.5 × 3.1			FV	40345	NP960
				2	76.5 × 1.5 × 3.1					
				0	76.5 × 3 × 2.8					
		●Aveo	4	1	76.5 × 1.5 × 3.1			FV	40134	
				2	76.5 × 1.5 × 3.1					
				0	76.5 × 2 × 2.5					
		●Aveo Family	4	1	76.5 × 1.5 × 3.2	RN		FV	40152	93742961 S122014
				2	76.5 × 1.5 × 3.2					
				0	76.5 × 2 × 2.8					
	1400	●Chevrolet Corsa1.4	4	1	77.6 × 1.5 × 3.1			SV	40470	93227615
				2	77.6 × 1.5 × 3					
				0	77.6 × 3 × 3.4					
		●Chevrolet Aveo	4	1	79 × 1.2 × 3.3			SV	40046	93740225
				2	79 × 1.5 × 3.3					
				0	79 × 3 × 2.8					
	1600	●Chevrolet Corsa1.6	4	1	79 × 1.2 × 2.9			SV	40390	93235611
				2	79 × 1.5 × 3.3					
				0	79 × 3 × 2.8					
		●Sonic	4	1	79 × 1.2 × 2.7			SV	40801	55581399
				2	79 × 1.2 × 3.2					
				0	79 × 2.5 × 2.2					
C18NE		●Astra	4	1	80.5 × 1.2 × 3.1		Cr4	SV	40174	93294730
				2	80.5 × 1.2 × 2.9					
				0	80.5 × 2 × 3.1					
	1600	●Lanos ●Nubira ●Espero	4	1	79 × 1.2 × 2.9			SV	40138	S1220014
				2	79 × 1.5 × 3.3					
				0	79 × 3 × 2.8					
エンジン型式	排気量	車名・型式	シリン ダー数	位置	サイズ 径×巾×厚さ	材質	表面改質	セットタイプ	セットNo.	備考
ピストンリング										

Engine Type	cc	Vehicle Model Chassis Type	Cyl. No.	Piston Ring					Remarks
				Position	Size (mm) d ₁ ×h ₁ ×a ₁ (D×B×T)	Material	Surface Treatment	Set Type	

統 DAEWOO

○——ガソリン車 Gasoline-engine Automobiles

※ (): OLD SET No.

	1800	●Chevrolet Optra1.8	4	1	81.6 × 1.2 × 3.1		GN	SV	40900	92067238
				2	81.6 × 1.5 × 3.4					
				0	81.6 × 3 × 2.8					
		●Capti	4	1	88 × 1.2 × 3.3			SV	40156	12631103
				2	88 × 1.5 × 4					
				0	88 × 2 × 2.8					
エンジン型式	排気量	車名・型式	シリンダー数	位置	サイズ 径×巾×厚さ	材質	表面改質	セットタイプ	セットNo.	備考
ピストンリング										

Engine Type	cc	Vehicle Model Chassis Type	Cyl. No.	Piston Ring						Remarks
				Position	Size (mm) d ₁ ×h ₁ ×a ₁ (D×B×T)	Material	Surface Treatment	Set Type	Set No.※	

統 DAEWOO

○—ディーゼル車 Diesel-engine Automobiles

※(): OLD SET No.

DB58			1	1	102 × 2.98 × 4.3	RN		FM	40182	65 02503-8058
				2	102 × 2.5 × 4.3					
				0	102 × 4 × 2.5					
2366		●8.5ton Dump Truck Bus BS106 Excavator Generator 115K Forklift	6	1	123 × 3.332 × 5			FX	40822	IST=KEYSTONE
				2	123 × 3 × 5					
				0	123 × 4 × 2.95					
DE12T1			4	1	123 × 3.33 × 4.5	RN		FM	40200	65 02503-8237
				2	123 × 3 × 5					
				0	123 × 4 × 2.5					
284Z01		●15ton Dump Truck Bus BH120 Excavator Generator 200K	8	1	128 × 3.332 × 5.1			FX	40076	65 02503-8251
				2	128 × 3 × 5.1					
				0	128 × 5.5 × 3.7					
2848 NEW		●15ton Dump Truck Bus BH126 Excavator Generator 200K	8	1	128 × 3.332 × 5.1			FX	40821	65 02503-8252
				2	128 × 3 × 5.1					
				0	128 × 5 × 3.5					
エンジン型式	排気量	車名・型式	シリン ダー数	位置	サイズ 径×巾×厚さ	材質	表面改質	セットタイプ	セットNo.	備考
ピストンリング										

Examples of Piston Ring Troubles

Deterioration of Lubrication Oil, Excess Heat, etc.

Deterioration of Lubrication Oil, Excess Heat, etc.



Piston and Piston Ring Scuffing

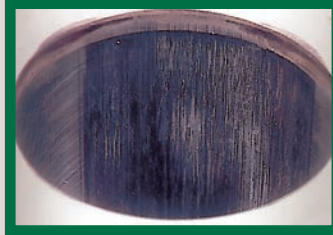

Scuffed Surface of Cylinder Liner

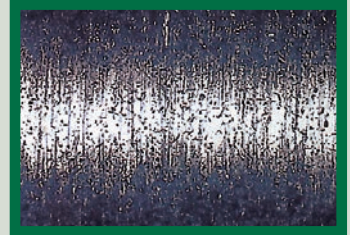

Typical Piston Ring Running Surface After Engine Operation

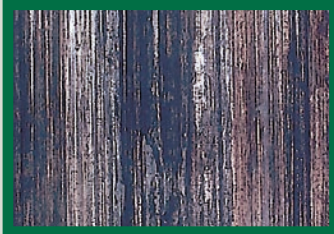

Scuffed Running Face of Piston Ring



Piston Ring Sticking



Accumulated Carbon Deposit on Piston Ring Side face



Aluminum Micro-Welding on Piston Ring Side Face



Piston Ring Breakage Caused by Excessive Piston Groove Wear

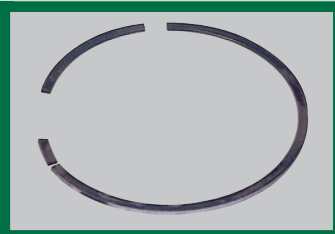

Piston Ring Breakage

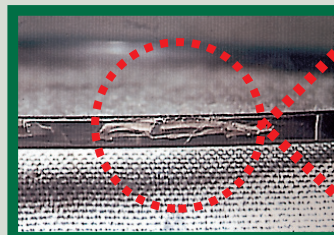

Coating Flaking of Piston Ring Running Face

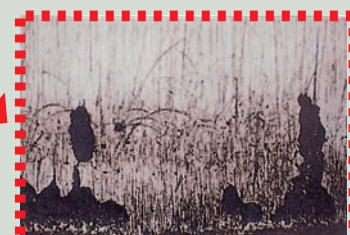
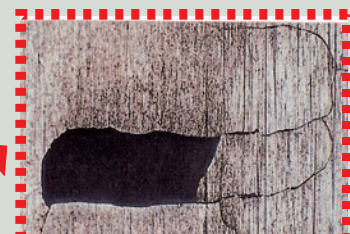

Foreign Particle Contamination Improper Assembly Corrosion

Foreign Particle Contamination



Typical Piston Ring Running Face After Engine Operation



Scratch Marks on Piston Ring Running Face Caused By Foreign Particles



Foreign Particles Stuck on Piston Ring Running Surface

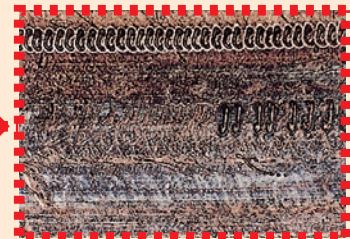
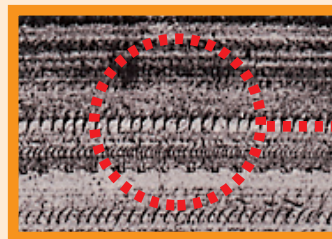

Chain Marks Due to Foreign Particles on Piston Ring Side Face

Improper Assembly

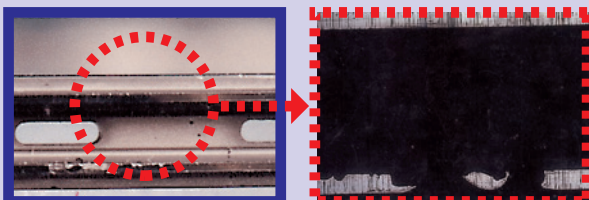

Oil Ring Rail Chipping Caused by Improper Assembly

Corrosion

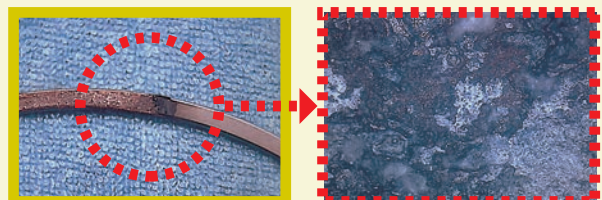

Piston Ring Side Face Corrosion

Location of the hologram stickers on the package

A) Only NEW hologram sticker is put on the package.



B) Previous hologram sticker is also put on the package.



Features of NEW hologram sticker

Appearance

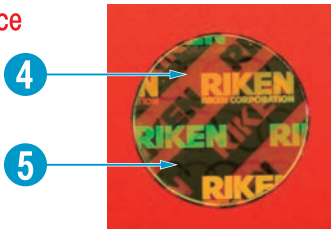

Viewer verification

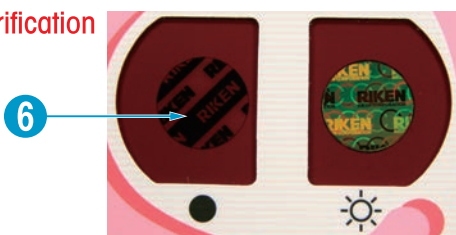

ENGLISH

From Riken's shipment in January 2008, new hologram sticker will be put on the package.

- 1 UPPER LEFT : NEW hologram Sticker
- 2 UPPER LEFT : NEW hologram Sticker
- 3 UPPER RIGHT : Previous hologram sticker
- 4 The color of package can be seen in transparent area.
- 5 Company logo "RIKEN" and stripes can be seen.
- 6 Only company logo "RIKEN" and stripes can be seen.

ESPAÑOL

En los envíos de RIKEN desde Enero de 2008, se pegará el sello del nuevo holograma en el paquete

- 1 Arriba a la izquierda : El sello nuevo
- 2 Arriba a la izquierda : El sello nuevo
- 3 Arriba a la derecha : El sello anterior
- 4 Se puede ver el color del paquete por la zona transparente
- 5 Se puede ver el logo de la compañía RIKEN y las rayas
- 6 Se puede ver solamente el logo de la compañía RIKEN y las rayas

中文

从 2008 年 1 月起，理研出厂的产品包装盒上将改用新版的全息图像标签。

- 1 左上方：新的全息图像标签
- 2 左上方：新的全息图像标签
- 3 右上方：全息图像标签
- 4 透明部分能看见包装盒的颜色
- 5 可以看见理研公司的商标和条纹
- 6 只能看到理研公司的商标和条纹

فارسی

از حمل ماه ژانویه سال ۲۰۰۸ نوع برجسب هولوگرام عوض خواهد شد.

- 1 برجسب هولوگرام جدید در قسمت بالای جعبه سمت چپ چسبانده شده است.
- 2 برجسب هولوگرام جدید در قسمت بالای جعبه سمت چپ چسبانده شده است.
- 3 برجسب هولوگرام قدیمی در قسمت بالای جعبه سمت راست چسبانده شده است.
- 4 رنگ قرمز جعبه RIKEN از روی هولوگرام نیز مشاهده می شود.
- 5 مارک RIKEN و حاشیه مورب که روی آن RIKEN نوشته شده در هولوگرام بدون عینک RIKEN نیز مشاهده می شود.
- 6 با عینک RIKEN از درجه روشن آن مارک RIKEN بصورت رنگی دیده می شود و از درجه تاریک آن حاشیه مورب سیاه و کلمه RIKEN دیده می شود.

عربي

من شركة الشحن ريكين (Riken) في يناير ٢٠٠٨، سوف يتم وضع ملصق مجسم جديد على الرزمة.

- 1 أعلى اليسار : الملصق المجسم الجديد
- 2 أعلى اليسار : الملصق المجسم الجديد
- 3 أعلى اليمين : الملصق المجسم السابق
- 4 لون الرزمة يمكن رؤيته في المنطقة الشفافة.
- 5 علامة الشركة "RIKEN" وشرطة الرزم يمكن رؤيتها.
- 6 علامة الشركة "RIKEN" وشرطة الرزم فقط يمكن رؤيتها.

Rational production systems give birth to high quality products

We have developed a comprehensive production system to provide products that fully respond to the needs of users.

At our three main production centers, the Kashiwazaki plant and the Tsurugi plant in Niigata and the Kumagaya plant in Saitama, very early on we installed production control systems and factory automation systems using automatic handling equipment, numerically controlled machines, automatic inspection equipment and computer systems. We use the latest machining equipment with specialized lines for each product group and we have achieved high quality, low cost and short production time through our highly rationalized production systems. The thorough total quality control (TQC) system utilizes our in company developed evaluation technology and our users place a high degree of confidence in our products. We take very thorough measures to ensure the preservation of the environment and maintain a harmonious relationship with local communities.

■ Kashiwazaki Plant

Address : 1-37 Hokutocho, Kashiwazaki, Niigata, 945-8555

Plant site area : 293,304m²

Products : Engine parts such as piston rings, other parts for automobiles, construction machinery, industrial equipment, hydraulic and pneumatic compressors and nuclear plants.

■ Tsurugi Plant

Address : 949-1 Aza Shimosakai, Oasa Tsurugi, Kashiwazaki, Niigata, 945-0105

Plant site area : 56,700m²

Products : Steel piston rings

■ Kumagaya Plant

Address : 4-14-1 Suehiro, Kumagaya, Saitama, 360-8522

Plant site area : 153,825m²

Products : Valve system parts, pipe fittings, industrial furnaces, electric heating wires, refractory products, waste incinerators, magnetic and electromagnetic wave shield materials, etc.





RIKEN 株式会社 **リケン**

海外営業部営業2部

●東京(本社)

〒102-8202 東京都千代田区三番町8-1 三番町東急ビル3階
TEL: (03) 3230-3923 FAX: (03) 3230-3432

●大阪営業所

〒541-0043 大阪府大阪市中央区高麗橋 4-1-1
TEL: (06) 4706-6757 FAX: (06) 4706-6758

RIKEN

RIKEN CORPORATION

<http://www.riken.co.jp>

●TOKYO

8-1, Sanbancho, Chiyoda-ku, Tokyo 102-8202, Japan
Telephone: (03) 3230-3923 FAX: (03) 3230-3432

●OSAKA

1-1 Kohraibashi 4-chome, Chuoh-ku, Osaka 541-0043, Japan
Telephone: (06) 4706-6757 FAX: (06) 4706-6758